

SIEMENS



3VM Molded Case Circuit Breakers

SENTRON

Catalog
LV 31

Edition
2018

[siemens.com/lowvoltage](https://www.siemens.com/lowvoltage)

Related catalogs

Low-Voltage Power Distribution and Electrical Installation Technology LV 10
 SENTRON • SIVACON • ALPHA
 Protection, Switching, Measuring and Monitoring Devices, Switchboards and Distribution Systems

PDF (E86060-K8280-A101-A7-7600)
 Print (E86060-K8280-A101-A6-7600)



3VA Molded Case Circuit Breakers with UL and IEC Certification
 SENTRON

PDF/print (E86060-K8290-A101-A2-7600)



Industrial Controls IC 10
 SIRIUS

PDF (E86060-K1010-A101-A8-7600)



Industrial Communication IK PI
 SIMATIC NET

E86060-K6710-A101-B8-7600



DELTA ET D1
 Switches and Socket Outlets

PDF



SITRAIN
 Training for Industry

www.siemens.com/sitrain



Catalog PDF / Contact

Catalog PDF

Digital versions of the catalogs are available in the Siemens Industry Online Support.

www.siemens.com/lowvoltage/catalogs



Contact

Your personal contact can be found in our Contacts Database at:

www.siemens.com/automation-contact



Industry Mall / TIA ST / CA 01

Industry Mall

Information and Ordering Platform on the Internet:

www.siemens.com/industrymall



Siemens TIA Selection Tool

for the selection, configuration and ordering of TIA products and devices

www.siemens.com/tst



Products for Automation and Drives CA 01

Interactive Catalog Download

www.siemens.com/ca01download



Trademarks

All product designations may be registered trademarks or product names of Siemens AG or other supplying companies. Third parties using these trademarks or product names for their own purposes may infringe upon the rights of the trademark owners. Further information about low-voltage power distribution and electrical installation technology is available on the Internet at:

www.siemens.com/lowvoltage

Technical Support

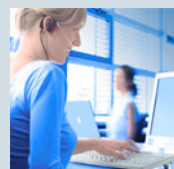

Expert advice on technical questions with a wide range of demand-optimized services for all our products and systems.

www.siemens.com/lowvoltage/support-request

3VM Molded Case Circuit Breakers

SENTRON



Catalog LV 31 · 2018

Supersedes:
Catalog LV 31 · 2016

Refer to the Industry Mall for current updates of this catalog:

www.siemens.com/industrymall

© Siemens AG 2018

Introduction	1
3VM Molded Case Circuit Breakers up to 630 A, TM, 400 V, up to 55 kA	2
Accessories and Spare Parts	3
Appendix	4

The products and systems listed in this catalog are developed and manufactured using a certified quality management system in accordance with EN ISO 9001:2008.

Your economic solution

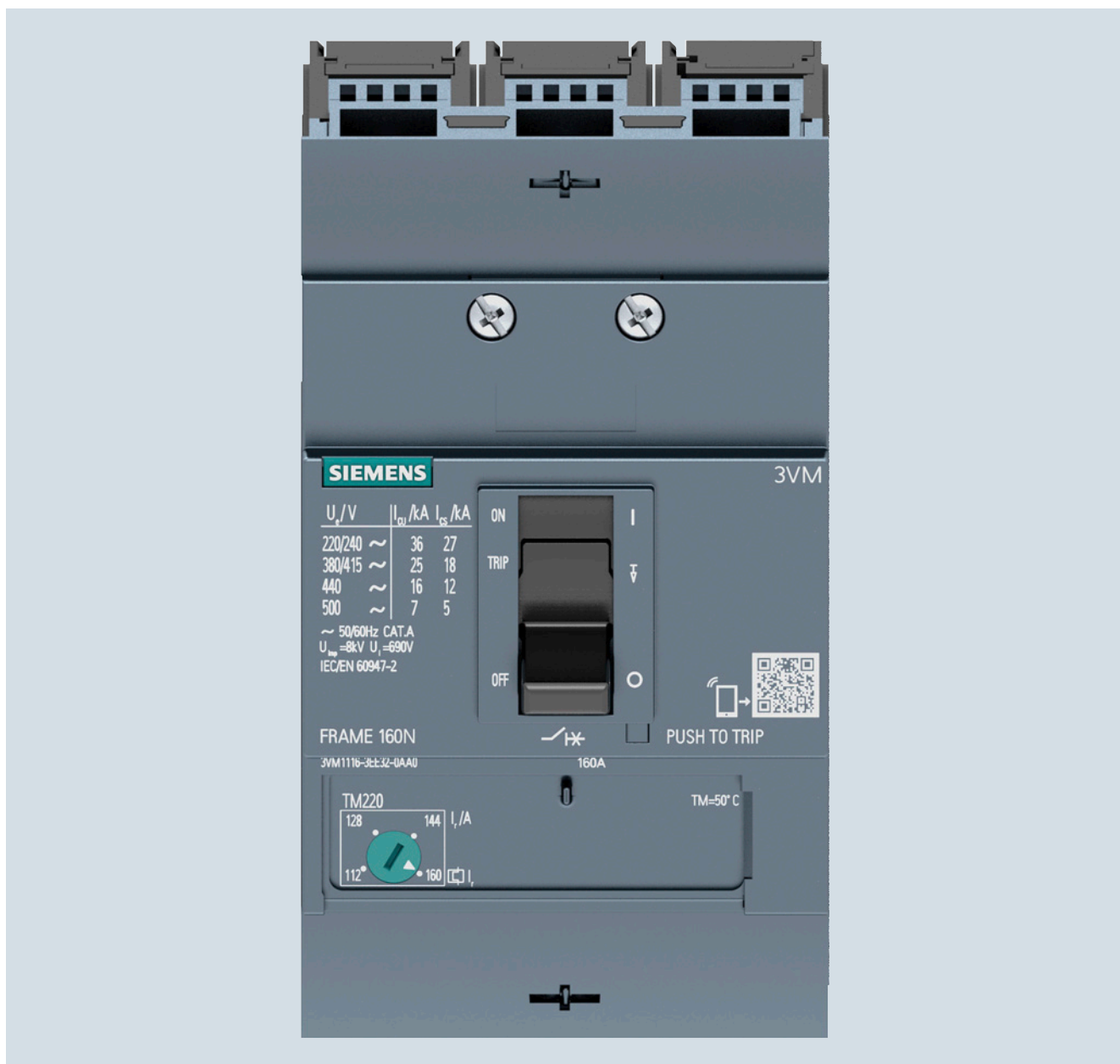

The 3VM molded case circuit breaker is ideally suited to basic applications in infrastructure requiring a reliable and economic solution. In addition to a selection of basic units, the compact product portfolio also encompasses the essential accessory components that perfectly cover your central requirements.

Rely on proven Siemens quality, and benefit at the same time from an excellent price-performance ratio. The 3VM molded case circuit breaker offers the following advantages:

- Compact portfolio for all basic applications
- Superior cost effectiveness – the right performance at the right price
- Global and comprehensive Service & Support – at any time, whatever your location
- Reliable quality and punctual delivery – thanks to the global standards of Siemens

Wide range of accessories for flexible use

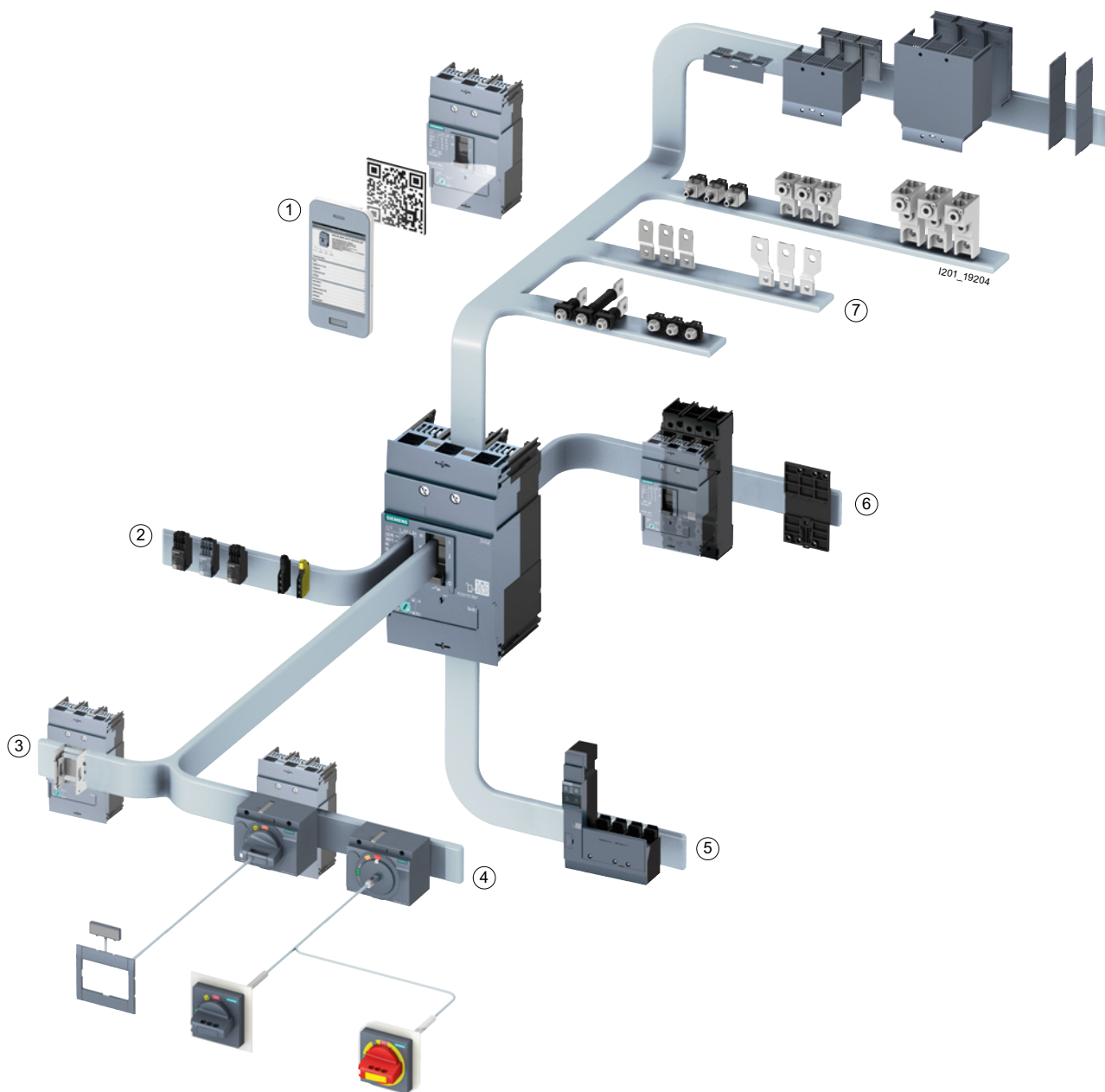

- ① Knowledge Manager
- ② Internal accessories
- ③ Locking and interlocking
- ④ Manual operators

- ⑤ Residual current device (RCD)
- ⑥ Plug-in technology, DIN rail adapter
- ⑦ Connection technology

The 3VM molded case circuit breakers from the portfolio of SENTRON protection, switching, measuring and monitoring devices ensure the reliable protection of people and property as integral components of efficient power distribution systems. With the help of essential accessory components, they can be adapted flexibly, quickly and simply to central customer requirements.

Notes

Introduction



3VM Molded Case Circuit Breakers

- 1/2 General data
- 1/2 – Overview
- 1/9 – Design
- 1/17 – Application

For further technical product information:

Siemens Industry Online Support:
www.siemens.com/lowvoltage/product-support

- Entry type:
 - Application example
 - Certificate
 - Characteristic
 - Download
 - FAQ
 - Manual
 - Product note
 - Software archive
 - Technical data

Introduction

3VM Molded Case Circuit Breakers

General data

Overview

Frame Size

The 3VM molded case circuit breakers are an integral component of our cost-effective power distribution system, and they are used to protect personnel and property assets.

The new 3VM molded case circuit breakers set standards in the modularity of their internal and external accessories. The modularity of the accessory components across all sizes, and their speed of installation save time and cut costs.

The new molded case circuit breakers are available in 3 and 4-pole versions (100 A, 160 A, 250 A, 400 A and 630 A) as well as in 1 and 2-pole versions (160 A).

The circuit breakers are available with rated operational currents ranging from 16 A to 630 A and rated voltages up to 500 V, depending on the size.

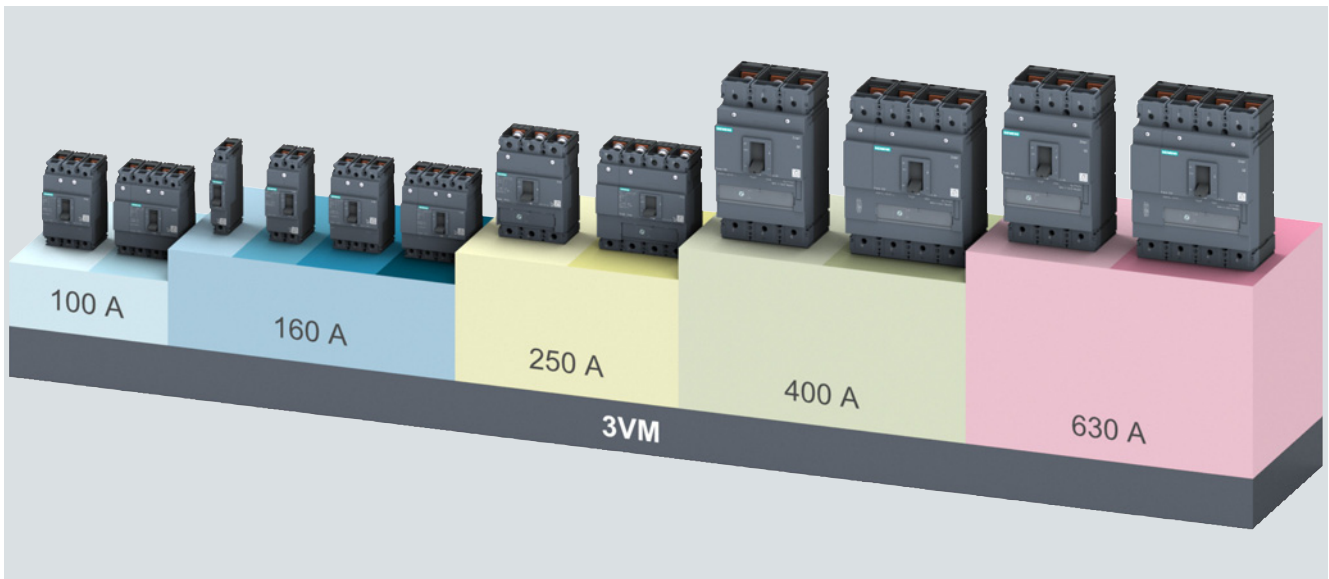

Main features

The new 3VM molded case circuit breakers reliably perform all the tasks required for line protection.

Features

The key features of the 3VM series are:

- Compact design
- Depending on size: 1-pole to 4-pole versions
- Depending on size: breaking capacities of 16 kA ... 55 kA at 415 V, 3 or 4-pole breakers and 36 kA at 240 V, 1-pole breakers
- Fixed-mounted, plug-in version
- Thermal-magnetic trip units
- AC/DC applications
- No derating up to +50 °C
- Modular and easy-to-fit internal accessories with diverse functions
- Universal platform of accessories across all sizes

Compact dimension

Thanks to a mounting depth of 70 mm and a cover size of 45 mm, the 3VM molded case circuit breakers of sizes 100 A, 160 A and 250 A are predestined for protecting cables and lines in the plant area, especially for the electrical installation area. For these applications, there are also a wide range of accessories available such as adapters for installation on standard mounting rails, as well as residual current devices (RCD110 and RCD210) that can be side-mounted.

Trip unit

A thermal-magnetic principle trip unit is the basic trip unit for providing overload and short-circuit protection. This has been developed for implementing economical, cost-efficient installations. It is suitable for use in three-phase AC networks, 400 Hz applications, and DC applications.

Introduction

3VM Molded Case Circuit Breakers

General data

3VM up to 630 A



Type	3VM10	3VM11		
Number of poles	3, 4	1	2	3, 4

3VM molded case circuit breakers for line protection, standard applications

Electrical characteristics according to IEC 60947-2

Size		100 A	160 A	160 A	160 A
Rated operational current I_n at 50 °C ambient temperature	A	16 ... 100	16 ... 160	16 ... 160	16 ... 160
Rated operational voltage U_e 50/60 Hz AC	V	500	415	415	500
Rated insulation voltage U_i	V	690	500	500	690
Rated impulse withstand voltage U_{imp}	kV	8	8	8	8
Use in IT networks		✓	✓	✓	✓
Frequency	Hz	0 ... 400	0 ... 400	0 ... 400	0 ... 400

Breaking capacity

(B) (N) (S) (N) (S) (N) (S) (N) (S) (M)

Rated ultimate short-circuit breaking capacity I_{cu}

RMS value, according to IEC 60947-2

220 - 240 V AC / 50/60 Hz	kA	25	36	55	25	36	36	55	36	55	85
380 - 415 V AC / 50/60 Hz	kA	16	25	36	5	6	25	36	25	36	55
440 V AC / 50/60 Hz	kA	8	16	25	--	--	--	--	16	25	36
500 V AC / 50/60 Hz	kA	5	5	7	--	--	--	--	7	7	10
125 V DC (1 switching pole)	kA	--	--	--	16	25	16	25	--	--	--
250 V DC (2 switching poles)	kA	25	36	55	--	--	36	55	36	55	85
500 V DC (3 switching poles)	kA	25 ¹⁾	36 ¹⁾	55 ¹⁾	--	--	--	--	36	55	85

Rated service short-circuit breaking capacity I_{cs}

RMS value, according to IEC 60947-2

220 - 240 V AC / 50/60 Hz	kA	12	18	18	18	27	27	41	27	41	63
380 - 415 V AC / 50/60 Hz	kA	8	12	12	3	4	18	27	18	27	41
440 V AC / 50/60 Hz	kA	4	8	8	--	--	--	--	12	18	27
500 V AC / 50/60 Hz	kA	2.5	2.5	2.5	--	--	--	--	5	5	5
125 V DC (1 switching pole)	kA	--	--	--	16	25	16	25	--	--	--
250 V DC (2 switching poles)	kA	25	36	55	--	--	36	55	36	55	85
500 V DC (3 switching poles)	kA	25 ¹⁾	36 ¹⁾	55 ¹⁾	--	--	--	--	36	55	85

✓ Available -- Not available

¹⁾ I_{cu} and I_{cs} data only valid for 4-pole breakers. Max. V DC for 3-pole breakers: 250 V DC.

3VM up to 630 A



3VM12

3VM13 **NEW**

3VM14 **NEW**

3, 4

3, 4

3, 4

3VM molded case circuit breakers for line protection, standard applications

250 A

400 A

630 A

160 ... 250

320 ... 400

500 ... 630

500

500

500

690

690

690

8

8

8

✓

✓

✓

0 ... 400

0 ... 400

0 ... 400

S

M

S

M

S

M

55

85

55

85

55

85

36

55

36

55

36

55

25

36

36

55

36

55

10

15

25

36

25

36

--

--

--

--

--

--

55

85

*)

*)

*)

*)

55

85

8

16

8

16

41

63

41

63

41

63

27

41

27

41

27

41

18

27

27

41

27

41

7

10

18

27

18

27

--

--

--

--

--

--

55

85

*)

*)

*)

*)

55

85

8

16

8

16

*) on request

Introduction

3VM Molded Case Circuit Breakers

General data

1



Type	3VM10	3VM11	3VM11	3VM11	
------	-------	-------	-------	-------	--

Line protection

Service life

Mechanical	10000	12000	12000	12000
Electrical 380 ... 415 V	2000	6000	6000	6000

Trip units	FTFM	TM210	✓	✓	✓	✓
	ATFM	TM220	--	--	--	✓

Starter combinations (IEC 60947-4)

Rated operational current I_n at 50 °C ambient temperature	A	--	--	--	32 ... 125
---	---	----	----	----	------------

Service life

Mechanical	--	--	--	12000
Electrical 380 ... 415 V	--	--	--	6000

Trip units	AM	TM120M	--	--	--	✓
------------	----	--------	----	----	----	---

Switch disconnectors

Electrical characteristics according to IEC 60947-3

Number of poles	--	--	--	3, 4
Rated operational current I_n at 50 °C ambient temperature	A	--	--	63, 100, 125, 160
Rated operational voltage U_e AC 50/60 Hz	V	--	--	500
Rated operational voltage U_e DC	V	--	--	500
Rated short-circuit breaking capacity I_{cm} with upstream circuit breaker	kA	--	--	55 kA at 415 V
Rated short-time withstand current I_{cw}	kA (1s)	--	--	2

Dimensions

	A	mm	76.2 (3p)/101.6 (4p)	25.4	50.8	76.2 (3p)/101.6 (4p)
	B	mm	130	130	130	130
	C	mm	70	70	70	70
	D	mm	88	88	88	88

Weight	1-pole	Lug terminal	kg	3-pole	0.90	--	--	0.90
				2-pole	--	--	0.60	--
				4-pole	1.15	--	--	1.15

General information

Utilization category according to IEC 60947-2	A	A	A	A
Power infeed direction	Top and bottom	Top and bottom	Top and bottom	Top and bottom
Standard connection system	Lug terminal	Lug terminal	Lug terminal	Lug terminal
Isolating features according to IEC 60947	✓	✓	✓	✓

✓ Available -- Not available

*) available as of 2019



3VM12

3VM13 **NEW**3VM14 **NEW**

12000	12000	12000
6000	6000	6000
✓	✓	✓
✓	✓	✓
160, 200	250, 320	400, 500
12000	12000	12000
6000	6000	6000
✓	✓	✓
3, 4	3, 4	3, 4 ^{*)}
250	400	630
500	500	500
500	500	500
55 kA at 415 V	55 kA at 415 V	55 kA at 415 V
3	4, 8	4, 8
105 (3p)/140 (4p)	138 (3p)/184 (4p)	138 (3p)/184 (4p)
158	248	248
70	110	110
88	137	137
--	--	--
--	--	--
1, 8	4, 3	4, 3
2, 3	4, 8	4, 8
A	A	A
Top and bottom	Top and bottom	Top and bottom
Lug terminal	Lug terminal	Lug terminal
✓	✓	✓

*) available as of 2019

Introduction

3VM Molded Case Circuit Breakers

1

General data

Molded case circuit breakers and accessories in the system

The new 3VM molded case circuit breakers come with a tailor-made portfolio of internal and external accessories which can be installed flexibly in any size of circuit breaker (depending on the type of accessory).

The table below shows the molded case circuit breakers in or on which the accessories can be installed, and the sizes covered by the same accessory component:

Accessories	Molded case circuit breakers				
	3VM				
	100 A	160 A	250 A	400 A	630 A
Auxiliary switches and alarm switches					
Auxiliary releases					
Connection technology					
Plug-in technology					
Front mounted rotary operator					
Door mounted rotary operator					
Locking technology: padlock					
Residual current device, mounted on the side (4-pole)					
Masking frame					
DIN rail adapter					

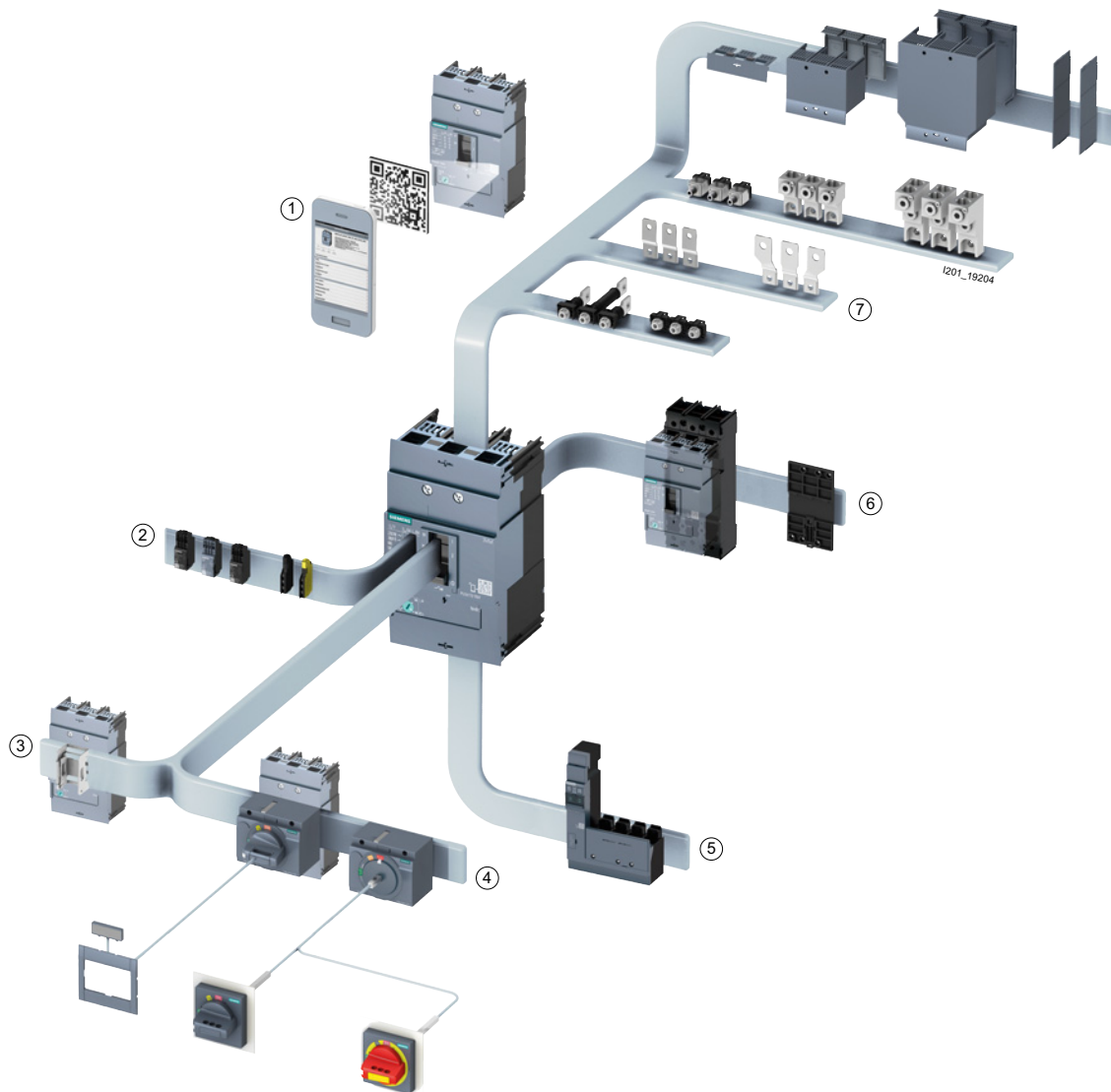

- ① Knowledge Manager
- ② Internal accessories
- ③ Locking and interlocking
- ④ Manual operators

- ⑤ Residual current device (RCD)
- ⑥ Plug-in technology, DIN rail adapter
- ⑦ Connection technology

Design**Integrated system**

The 3VM molded case circuit breakers set new standards, not only regarding technical features and functional scope, but design ergonomics too.

When it comes to operation, functionality and installation, the new 3VM series is a fully integrated system. This principle is embodied in the basic units and in all internal and external accessories.

The benefits offered by the internal and external accessories available for the 3VM molded case circuit breakers are:

- Standardized methods of operation
- Standardized functionality
- Standardized installation procedures
- Standardized accessories across all sizes 100 A ... 630 A (e.g. auxiliary switches, auxiliary releases, etc.)

Installation versions

3VM molded case circuit breakers are available in the following installation versions:

The right circuit breaker for all operation conditions

The new series of molded case circuit breakers can be equipped with additional components enabling them to be installed as fully functional switches in any location, a feature which affords maximum flexibility to system planners.

The following components can be used to suit the installation location:

- Handle
- Front mounted rotary operator
- Door mounted rotary operator

When the 3VM molded case circuit breaker is in the OFF position, it reliably disconnects all current paths of the circuit in accordance with IEC 60947-2 and IEC 60204-1.

The main switch functionality is not diminished by installation of the following accessories:

- Manual operator
- Residual current device

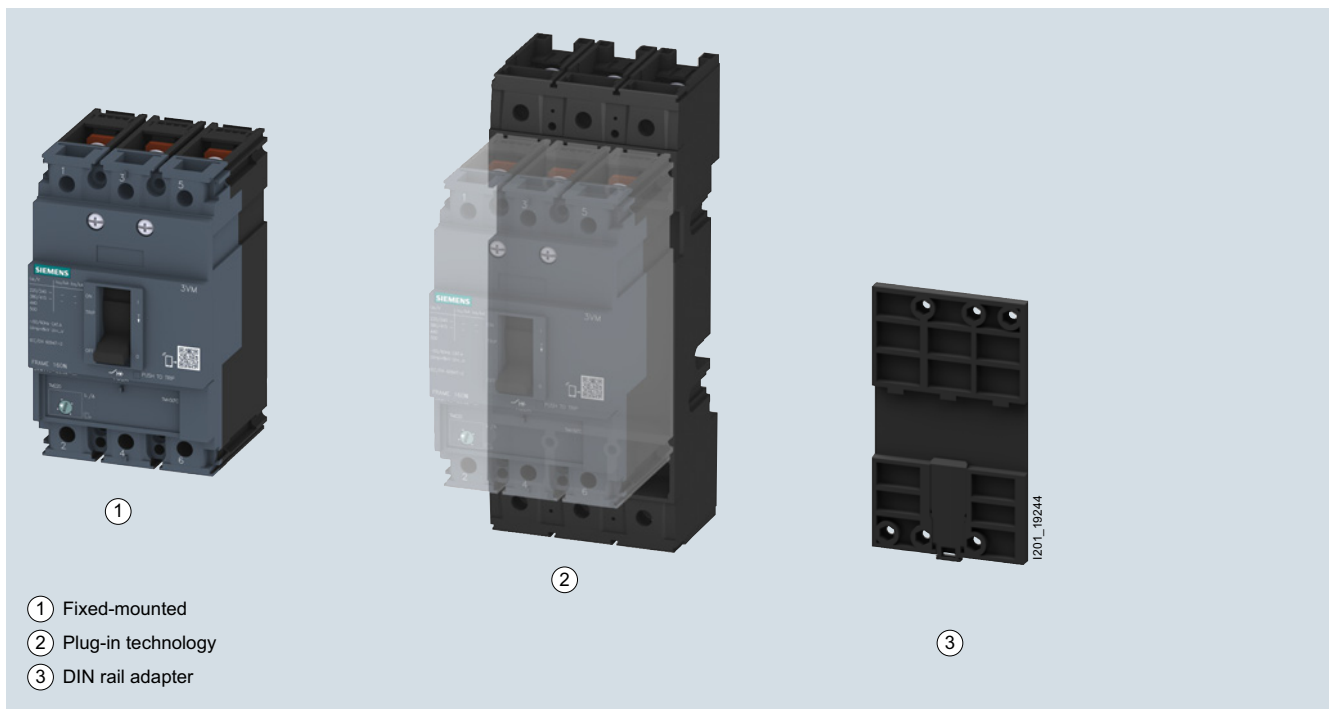

All versions offer the full range of functions, e.g. they can be equipped with every kind of accessory. For maintenance purposes, the plug-in design also provides the option of quickly replacing the breaker, or establishing visible electrical isolation in the main circuit.

Introduction

3VM Molded Case Circuit Breakers

General data

Ergonomic design of circuit breakers, control levers and control elements



Clear status indication

The possible switching positions of manual rotary operators are listed below:

- ON – Red marking
- TRIP – Yellow marking
- OFF – Green marking

The handle clearly engages in one of these positions depending on the status of the molded case circuit breaker. The switching positions are color-coded so that you can identify the status of the circuit breaker at a glance.

Broad range of accessories

The internal accessories (e.g. alarm and auxiliary switches, auxiliary releases, etc.) all belong to one family and can be installed on any size of circuit breaker. The accessories are designed for quick and easy installation. The components are coded to ensure that they are always installed at the correct position in the circuit breaker. The color recognizing system makes the functional selection easier than ever.

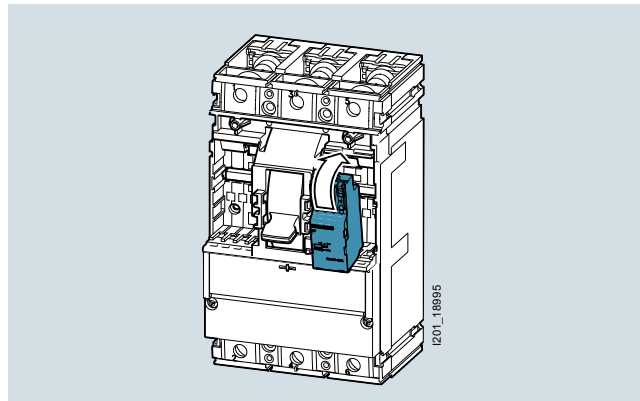

Connection technology

A large selection of connection systems is available for the new series of 3VM molded case circuit breakers.

The supported cable cross-sections are based on the frame size and the cable terminals used.

The connection accessories are easy to integrate in the new series of 3VM molded case circuit breakers.

You can implement various front and rear main conductor connections for the molded case circuit breakers in both types of installation (fixed-mounted and plug-in).

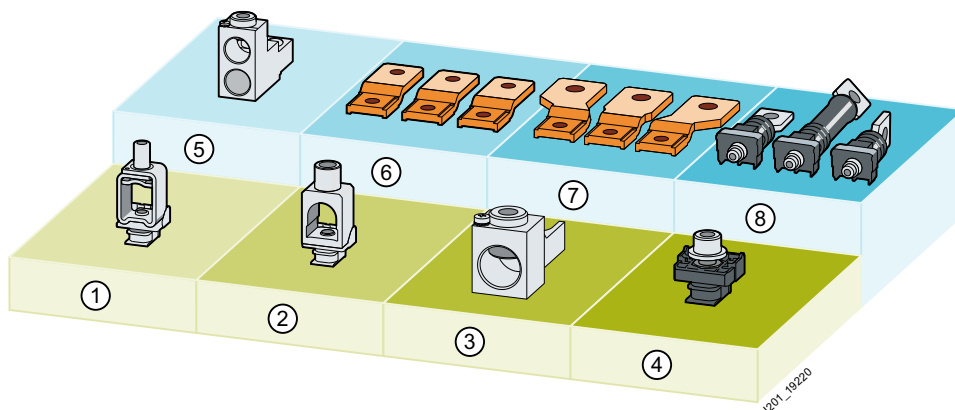

- | | |
|--------------------------------------|--|
| ① Box terminal | ⑤ Circular conductor terminal for 2 cables |
| ② Circular conductor terminal | ⑥ Front connection bars extended |
| ③ Circular conductor terminal, large | ⑦ Front connection bars broadened |
| ④ Lug terminal | ⑧ Rear terminal flat |

Technical detailsCircuit breaker identification

Each 3VM molded case circuit breaker has labels displaying all the important technical information, enabling unique identification:

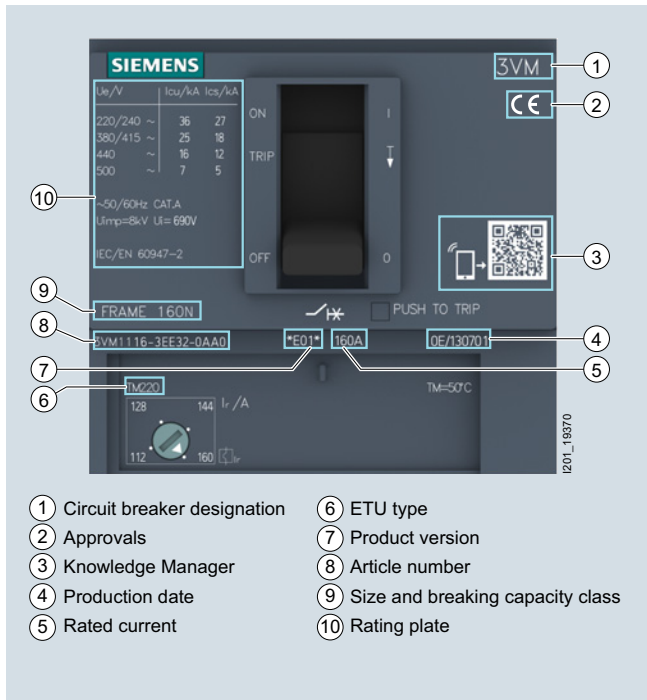

Front: Labeling

Knowledge Manager

By reading out the QR code using a smartphone and the "Siemens Industry Online Support" app, it is possible to view key product information via the Internet at any time.

Siemens provides the app free of charge.

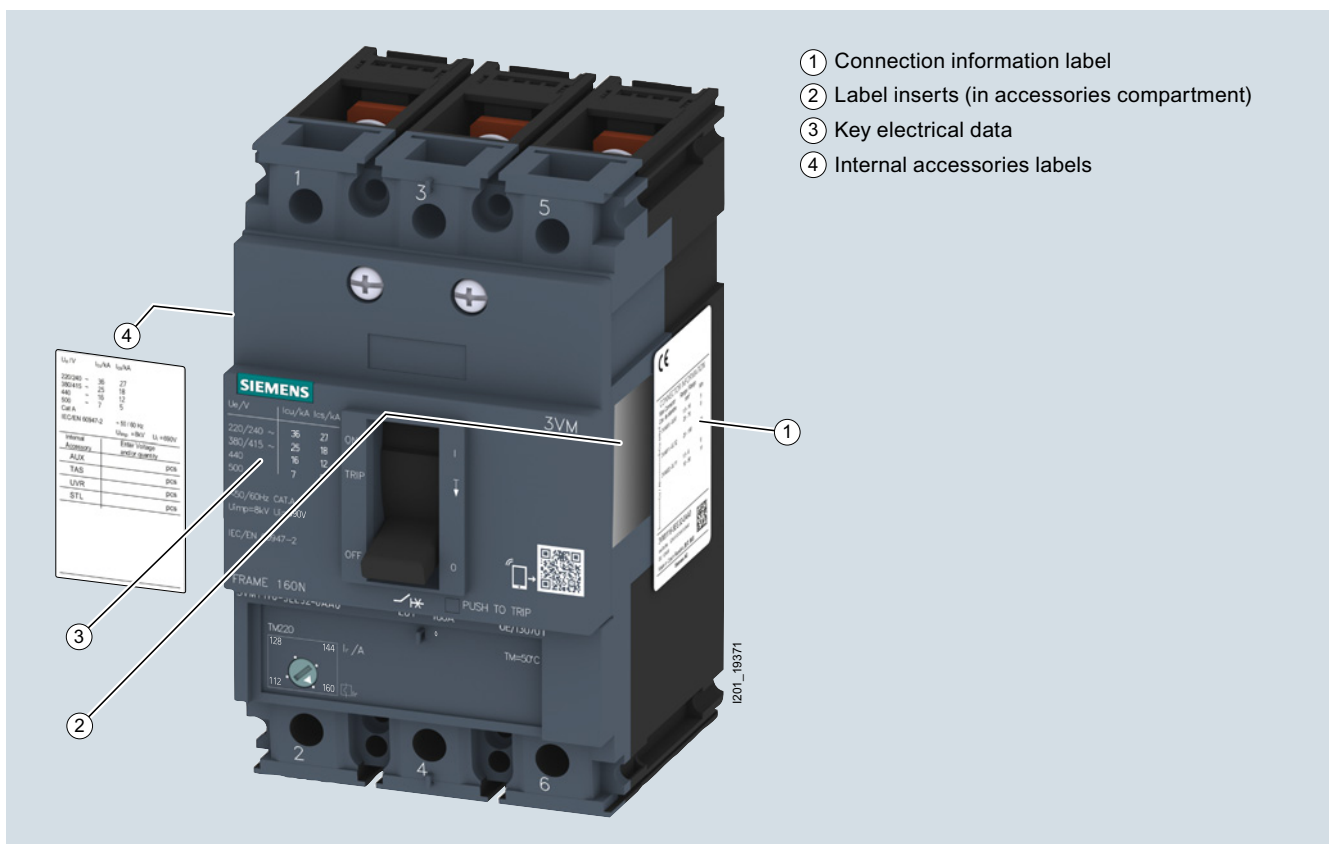

Breaker labeling

Introduction

3VM Molded Case Circuit Breakers

1

General data

Breaking capacity

The rated ultimate short-circuit breaking capacity I_{cu} is the maximum value of the short-circuit current which the protective device is capable of disconnecting in accordance with regulations. Up to this value, the protective device is also allowed to be used in a network.

The new 3VM molded case circuit breakers are available with various breaking capacity classes according to size and rated operational current range.

- Breaking capacity of the 3VM series, 2 to 4-pole at 415 V AC

Breaking capacity Class / I_{cu}	Size			
	3VM10 100 A 3 and 4-pole	3VM11 160 A 2, 3 and 4 pole	3VM12 250 A 3 and 4-pole	3VM13/14 400 A / 630 A 3 and 4-pole
B 16 kA	✓	--	--	--
N 25 kA	✓	✓	--	--
S 36 kA	✓	✓	✓	✓
M 55 kA	--	✓*)	✓	✓

*) only valid for 3- and 4- pole breakers

- Breaking capacity of the 3VM series, 1-pole at 240 V AC

Breaking capacity Class / I_{cu}	Size
	3VM11 160 A 1-pole
N 25 kA	✓
S 36 kA	✓

Standards and guidelines

The standards fulfilled by the 3VM molded case circuit breakers include:

- IEC / EN 60947-1
- IEC / EN 60947-2
- IEC / EN 60947-2, Appendix B, H and M
- IEC / EN 60947-3
- IEC / EN 60947-6-1

Electromagnetic compatibility

The 3VM molded case circuit breakers meet the requirements of the following standards:

- CISPR11, Class A and Class B
- IEC / EN 60947-1, Appendix S
- IEC / EN 60947-2, Appendix B, F, J and N

The 3VM molded case circuit breakers are adequately resistant to the following factors:

- Electrostatic charge
- Electrostatic discharge
- Electromagnetic waves, e.g. from transmission systems, mobile phones, radio telephone sets and radar systems
- Overvoltage, e.g. caused by lightning
- Voltage surges

Certificates

You can find information on the available certification (CE, CCC, FM, marine approvals) on the Internet (www.siemens.com/lowvoltage/product-support).

In the Entry List you can use the certificate type (general product approval, explosion protection, test certificates, shipbuilding, etc.) as a filter criterion.

Ambient conditions

- Pollution degree:
Operation of the 3VM molded case circuit breakers is approved in accordance with IEC / EN 60947-1 and IEC / EN 60664-1 for pollution degree 3.
- Ambient temperature:
- The 3VM molded case circuit breakers are used at ambient temperatures from -25 °C to +70 °C. At temperatures above +50 °C there are reductions in the rated operational current (derating).
- The permissible storage temperature in original Siemens packaging lies between -40 °C and +80 °C.
- Special climatic requirements:
The 3VM molded case circuit breakers can also be used in severe operating conditions.

Severe conditions for storage, transport and stationary use:
The molded case circuit breakers have passed the relevant special tests according to IEC / EN 60947-1, Appendix Q for use in Class E.

This class covers the areas MC3 + CC2 + SC1:

- Ambient temperature
- Humidity
- Vibration environment
- Shock environment

These ambient conditions can be referred to as "Open deck, damp and cold atmosphere without salt spray" or "Difficult, non-marine conditions".

The following standards-related criteria are complied with:

- IEC / EN 60068-2-2 "Bd" and IEC / EN 60068-2-1 "Ab":
Temperature range: -25 °C ... +70 °C
- IEC / EN 60068-2-30 "Db":
Humid heat up to 55 °C and air humidity up to 95 %
- IEC / EN 60068-2-6 "Fc"
Vibration test
- IEC / EN 60068-2-27 "Ea"
Shock resistance test

Between the tests of compliance with the standards and at the end of the tests, the usability of the devices is assured with the "Verification of operation characteristics".

- Vibration resistance and shock resistance:
- 3VM molded case circuit breakers are insensitive to vibrations and meet the requirements relating to mechanical and electromechanical vibration strength according to IEC / EN 60068 and the specifications of the shipbuilding societies.
- The circuit breakers resist impacts without tripping of up to 10 g and are tested to withstand their operating conditions without damage, with shock impact according to IEC / EN 60068-2-27 "Ea" with 150 m/s²/11 ms.
- Installation altitudes:
- When the 3VM molded case circuit breakers are used at up to 2000 m above sea level, the rated data will not change.
- An installation altitude above 2000 m can lead to higher temperatures at the switching devices. The decreased air density can significantly reduce heat dissipation, in turn reducing rated operational voltage, rated uninterrupted current and short-circuit values.

Refer to the table below for the calculation factor for determining the key values:

	Height			
	2000 m	3000 m	4000 m	5000 m
Breaking capacity I_{cu} / I_{cs}	1.00	0.90	0.80	0.70
Operating voltage U_{max}	1.00	0.90	0.80	0.70
Operating current $I_{max}^{1)}$	1.00	0.96	0.92	0.88
Current setting $I_r^{2)}$	1.00	1.02	1.04	1.06

²⁾ At maximum ambient temperature 50 °C

³⁾ Thermal-magnetic trip units only

Permissible mounting positions

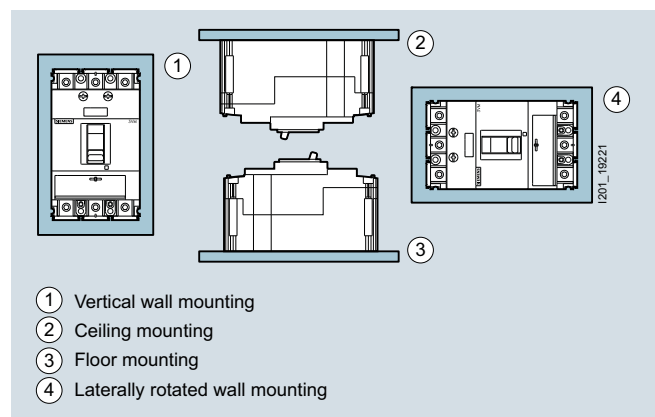

Positions in which the 3VM molded case circuit breakers are installed

Introduction



3VM Molded Case Circuit Breakers

1

General data

Further mounting positions, and mounting positions with accessories

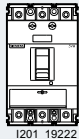
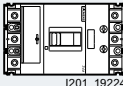
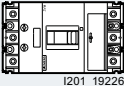
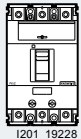
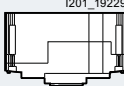
The following table shows the possible variations on the mounting positions, as well as mounting positions with accessories:

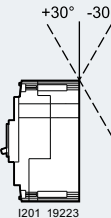
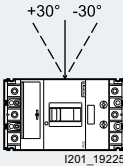
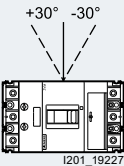
	Wall mounting vertical upright	horizontal right	horizontal left	vertical rotated	Ceiling mounting suspended	Floor mounting recumbent
						
						

3VM molded case circuit breakers

Basic circuit breaker (with internal accessories)	✓	✓	✓	✓	✓	✓
On DIN rail (with internal accessories)	✓	✓	✓	✓	--	✓

3VM molded case circuit breaker (3 and 4-pole) with accessories

Connection technology	✓	✓	✓	✓	✓	✓
Plug-in technology	✓	✓	✓	✓	--	--
Front mounted rotary operator	✓	✓	✓	✓	✓	✓
Door mounted rotary operator	✓	✓	✓	✓	✓	✓
Side-mounted RCD basic type A (RCD110, RCD210)	✓	✓	✓	✓	✓	✓
3-pole on 60 mm busbar system (with internal accessories)	✓	--	--	--	--	--

Degrees of protection

3VM molded case circuit breakers comply with the following degrees of protection as defined by IEC 60529 and IEC 60947-1, Appendix C:

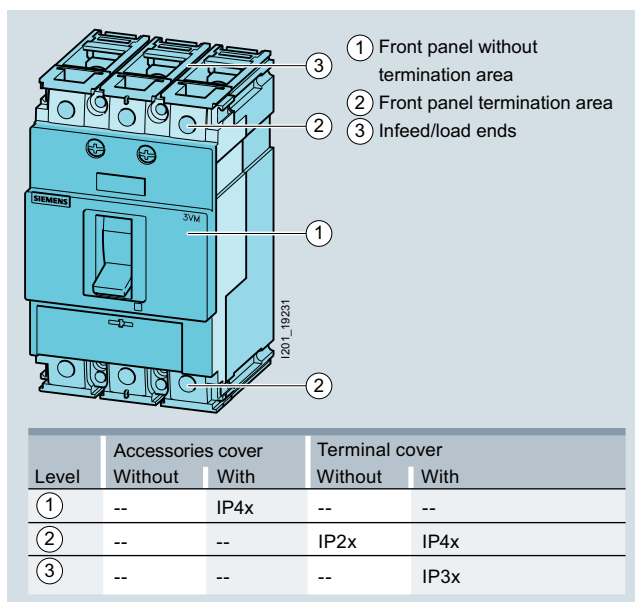

Environmental protection

The 3VM molded case circuit breakers meet the specifications of the European Environment Guideline 2002/95/EC RoHS (Restriction of the use of certain hazardous substances in electrical and electronic equipment). As little impact on the environment as possible was emphasized in their development and production.





A higher degree of protection up to IP65 can be achieved in combination with the following components:

- Door mounted rotary operator

Protection system

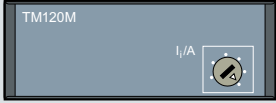
Description of functions

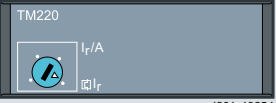
The table below illustrates the applications for which different types of thermal-magnetic trip units can be used:

		Thermal-magnetic			
		TM110M FM	TM120M AM	TM210 FTFM	TM220 ATFM
					
		I201_19523	I201_19240	I201_19253	I201_19254
Protection					
Starter protection		✓	✓	--	--
Line protection		--	--	✓	✓
Version available with					
100 A	3-pole	--	--	✓	--
	4-pole	--	--	✓	--
160 A	1-pole	--	--	✓	--
	2-pole	--	--	✓	--
	3-pole	✓	✓	✓	✓
	4-pole	--	--	✓	✓
250 A	3-pole	--	✓	✓	✓
	4-pole	--	--	✓	✓
400 A	3-pole	--	✓	✓	✓
	4-pole	--	--	✓	✓
630 A	3-pole	--	✓	✓	✓
	4-pole	--	--	✓	✓
Available protection parameters					
I_r adjustable		--	--	--	✓
I_i adjustable		--	✓	--	--
I_r fixed		--	--	✓	--
I_i fixed		✓	--	✓	✓
$I_N^{1)}$		--	--	✓	✓
Integrated functions					
Parameterizing		--		--	
			Setting and reading the parameters in A		Setting and reading the parameters in A

¹⁾ 3VM10 only without N protection.

3VM11 to 3VM14 without N protection or with 100% N protection

Introduction

3VM Molded Case Circuit Breakers

1

General data

Characteristic curves

To design a low-voltage switchboard in accordance with the valid rules, the system planner needs to dimension the protection settings of the molded case circuit breakers.

The settings selected for the trip unit of a molded case circuit breaker depend on the type of equipment to be protected. Tripping characteristics are represented graphically. In order to simplify the coordination of different protection devices, the current is specified as a multiple of the current setting value and the time is specified in seconds.

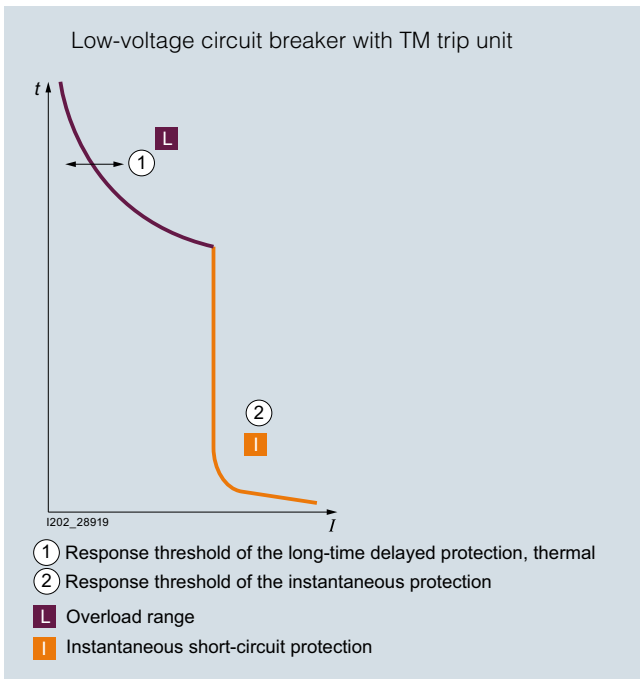

Tripping characteristics

Application

Detailed information about applications and possible uses

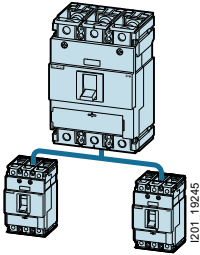
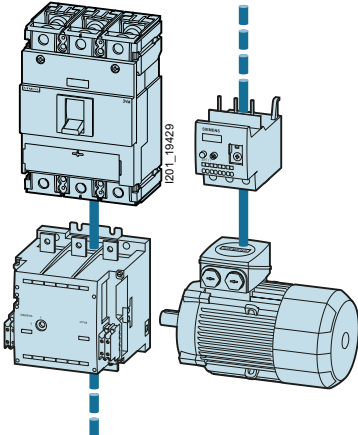
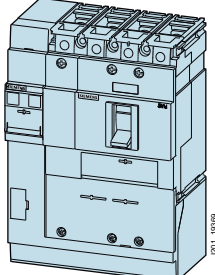
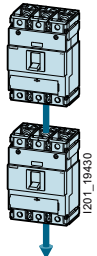
Application	3VM	Description
Line protection 	✓	<p>The trip units for line protection are designed to provide overload and short-circuit protection for:</p> <ul style="list-style-type: none"> • Cables • Lines • Non motorized loads
Protection for starter combinations (starter protection) 	✓	<p>Starter combinations consist of: molded case circuit breaker + contactor + overload relay.</p> <p>The molded case circuit breaker handles short-circuit protection and the isolating function. The task of the contactor is the operational switching of the feeder. The overload relay handles overload protection that can be specially matched to the motor. The molded case circuit breaker for the starter combination is therefore equipped with an adjustable and instantaneous short-circuit release.</p>
Residual current protection 	✓	<p>Residual current protective devices afford fault protection (formerly referred to as: protection in case of indirect contact) and supplementary protection (formerly referred to as: protection in case of direct contact) in low-voltage systems in the event of the basic insulation failing or live parts being touched. Their task is to prevent or reduce injury to personnel or livestock, or damage to property.</p>
Switch disconnectors 	✓	<p>Switch disconnectors are deployed:</p> <ul style="list-style-type: none"> • As main control switches • For on/off switching • For disconnection of loads • As switch disconnectors without overload and short-circuit protection <p>The switch disconnectors correspond to IEC / EN 60947-3.</p>

Introduction

3VM Molded Case Circuit Breakers

General data

1

3VM Molded Case Circuit Breakers up to 630 A, TM, 400 V, up to 55 kA



2/2	Line protection
2/12	Starter protection
2/13	Switch disconnectors
2/14	Dimensional drawings

For further technical product information:

Siemens Industry Online Support:
www.siemens.com/lowvoltage/product-support

→ Entry type:
 Application example
 Certificate
 Characteristic
 Download
 FAQ
 Manual
 Product note
 Software archive
 Technical data

3VM Molded Case Circuit Breakers up to 630 A, TM, 400 V, up to 55 kA

Line protection

Selection and ordering data

PU (UNIT, SET, M) = 1

PS*/P. unit = 1 UNIT

PG = 1CB



Connection technology

Type

Rated current
 I_n Current setting of the inverse-time delayed overload protection "L"
 I_r Operating current of the instantaneous short-circuit protection "I"
 I_i

DT

I_{cu} up to 25 kA at 240 V, low breaking capacity N

See "Overview", p. 1/2

N

Article No.
www.siemens.com/product?ArticleNo.

Basic price per PU

A

A

A

1-pole, fixed-mounted, 3VM11, up to 160 A Thermal-magnetic trip unit



I201_19253

Line protection, 1-pole, TM210 FTFM

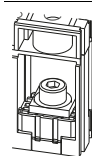
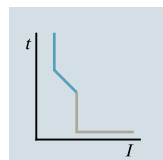
With fixed overload protection I_r and fixed short-circuit protection I_i 

Connection with lug terminal

3VM11

16	16	320
20	20	320
25	25	320
32	32	320
40	40	400
50	50	500
63	63	630
80	80	800
100	100	1000
125	125	1250
160	160	1600

3VM1196-3ED12-0AA0
3VM1120-3ED12-0AA0
3VM1125-3ED12-0AA0
3VM1132-3ED12-0AA0

3VM1140-3ED12-0AA0
3VM1150-3ED12-0AA0
3VM1163-3ED12-0AA0
3VM1180-3ED12-0AA0

3VM1110-3ED12-0AA0
3VM1112-3ED12-0AA0
3VM1116-3ED12-0AA0



Connection technology

Type

Rated current
 I_n Current setting of the inverse-time delayed overload protection "L"
 I_r Operating current of the instantaneous short-circuit protection "I"
 I_i

DT

I_{cu} up to 25 kA at 415 V, low breaking capacity N

See "Overview", p. 1/2

N

Article No.
www.siemens.com/product?ArticleNo.

Basic price per PU

A

A

A

2-pole, fixed-mounted, 3VM11, up to 160 A Thermal-magnetic trip unit



I201_19253

Line protection, 2-pole, TM210 FTFM

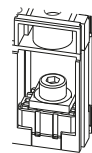
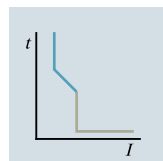
With fixed overload protection I_r and fixed short-circuit protection I_i 

Connection with lug terminal

3VM11

16	16	320
20	20	320
25	25	320
32	32	320
40	40	400
50	50	500
63	63	630
80	80	800
100	100	1000
125	125	1250
160	160	1600

3VM1196-3ED22-0AA0
3VM1120-3ED22-0AA0
3VM1125-3ED22-0AA0
3VM1132-3ED22-0AA0

3VM1140-3ED22-0AA0
3VM1150-3ED22-0AA0
3VM1163-3ED22-0AA0
3VM1180-3ED22-0AA0

3VM1110-3ED22-0AA0
3VM1112-3ED22-0AA0
3VM1116-3ED22-0AA0

3VM Molded Case Circuit Breakers up to 630 A, TM, 400 V, up to 55 kA

Line protection

PU (UNIT, SET, M) = 1

PS*/P. unit = 1 UNIT

PG = 1CB

Rated current I_n	DT	I_{cu} to 36 kA at 240 V, standard breaking capacity S S See "Overview", p. 1/2
		Article No. www.siemens.com/ product?Article.No.
A		Basic price per PU

Line protection, 1-pole, TM210 FTFMWith fixed overload protection I_f and fixed short-circuit protection I_f **Connection with lug terminal**

16	3VM1196-4ED12-0AA0
20	3VM1120-4ED12-0AA0
25	3VM1125-4ED12-0AA0
32	3VM1132-4ED12-0AA0
40	3VM1140-4ED12-0AA0
50	3VM1150-4ED12-0AA0
63	3VM1163-4ED12-0AA0
80	3VM1180-4ED12-0AA0
100	3VM1110-4ED12-0AA0
125	3VM1112-4ED12-0AA0
160	3VM1116-4ED12-0AA0

Rated current I_n	DT	I_{cu} to 36 kA at 415 V, standard breaking capacity S S See "Overview", p. 1/2
		Article No. www.siemens.com/ product?Article.No.
A		Basic price per PU

Line protection, 2-pole, TM210 FTFMWith fixed overload protection I_f and fixed short-circuit protection I_f **Connection with lug terminal**

16	3VM1196-4ED22-0AA0
20	3VM1120-4ED22-0AA0
25	3VM1125-4ED22-0AA0
32	3VM1132-4ED22-0AA0
40	3VM1140-4ED22-0AA0
50	3VM1150-4ED22-0AA0
63	3VM1163-4ED22-0AA0
80	3VM1180-4ED22-0AA0
100	3VM1110-4ED22-0AA0
125	3VM1112-4ED22-0AA0
160	3VM1116-4ED22-0AA0

3VM Molded Case Circuit Breakers up to 630 A, TM, 400 V, up to 55 kA

Line protection

PU (UNIT, SET, M) = 1

PS*/P. unit = 1 UNIT

PG = 1CB



Connection technology

Type

Rated current I_n

Current setting of the inverse-time delayed overload protection "L" I_r

Operating current of the instantaneous short-circuit protection "I" I_i

DT

I_{cu} up to 16 kA at 415 V, very low breaking capacity B
See "Overview", p. 1/2

(B)

Article No. www.siemens.com/product?ArticleNo.

Basic price per PU

A

A

A

3-pole, fixed-mounted, 3VM10 to 3VM14, up to 630 A
Thermal-magnetic trip unit



1201_19253

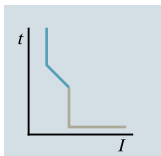

Line protection, TM210 FTFM

With fixed overload protection I_r and fixed short-circuit protection I_i

Connection with lug terminal

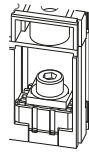

3VM10	16	16	320	3VM1096-2ED32-0AA0 3VM1020-2ED32-0AA0 3VM1025-2ED32-0AA0 3VM1032-2ED32-0AA0
	20	20	320	
	25	25	320	
	32	32	320	
	40	40	400	
	50	50	500	
	63	63	630	
	80	80	800	
	100	100	1000	
	3VM1010-2ED32-0AA0			
3VM11	16	16	320	--
	20	20	320	
	25	25	320	
	32	32	320	
	40	40	400	
	50	50	500	
	63	63	630	
	80	80	800	
100	100	1000		
125	125	1250		
160	160	1600		
3VM12	200	200	2000	--
	250	250	2500	
3VM13 NEW	320	320	3200	--
	400	400	4000	
3VM14 NEW	500	500	5000	--
	630	630	6300	

3VM Molded Case Circuit Breakers up to 630 A, TM, 400 V, up to 55 kA

Line protection

PU (UNIT, SET, M) = 1

PS*/P. unit = 1 UNIT

PG = 1CB

Rated current I_n	DT	I_{cu} up to 25 kA at 415 V, low breaking capacity N N		I_{cu} to 36 kA at 415 V, standard breaking capacity S S		I_{cu} up to 55 kA at 415 V, medium breaking capacity M M	
		See "Overview", p. 1/2		See "Overview", p. 1/2		See "Overview", p. 1/2	
		Article No. www.siemens.com/ product?Article.No.	Basic price per PU	Article No. www.siemens.com/ product?Article.No.	Basic price per PU	Article No. www.siemens.com/ product?Article.No.	Basic price per PU
A							

Line protection, TM210 FTFMWith fixed overload protection I_r and fixed short-circuit protection I_s **Connection with lug terminal**

16	3VM1096-3ED32-0AA0	3VM1096-4ED32-0AA0	--
20	3VM1020-3ED32-0AA0	3VM1020-4ED32-0AA0	--
25	3VM1025-3ED32-0AA0	3VM1025-4ED32-0AA0	--
32	3VM1032-3ED32-0AA0	3VM1032-4ED32-0AA0	--
40	3VM1040-3ED32-0AA0	3VM1040-4ED32-0AA0	--
50	3VM1050-3ED32-0AA0	3VM1050-4ED32-0AA0	--
63	3VM1063-3ED32-0AA0	3VM1063-4ED32-0AA0	--
80	3VM1080-3ED32-0AA0	3VM1080-4ED32-0AA0	--
100	3VM1010-3ED32-0AA0	3VM1010-4ED32-0AA0	--
16	3VM1196-3ED32-0AA0	3VM1196-4ED32-0AA0	3VM1196-5ED32-0AA0
20	3VM1120-3ED32-0AA0	3VM1120-4ED32-0AA0	3VM1120-5ED32-0AA0
25	3VM1125-3ED32-0AA0	3VM1125-4ED32-0AA0	3VM1125-5ED32-0AA0
32	3VM1132-3ED32-0AA0	3VM1132-4ED32-0AA0	3VM1132-5ED32-0AA0
40	3VM1140-3ED32-0AA0	3VM1140-4ED32-0AA0	3VM1140-5ED32-0AA0
50	3VM1150-3ED32-0AA0	3VM1150-4ED32-0AA0	3VM1150-5ED32-0AA0
63	3VM1163-3ED32-0AA0	3VM1163-4ED32-0AA0	3VM1163-5ED32-0AA0
80	3VM1180-3ED32-0AA0	3VM1180-4ED32-0AA0	3VM1180-5ED32-0AA0
100	3VM1110-3ED32-0AA0	3VM1110-4ED32-0AA0	3VM1110-5ED32-0AA0
125	3VM1112-3ED32-0AA0	3VM1112-4ED32-0AA0	3VM1112-5ED32-0AA0
160	3VM1116-3ED32-0AA0	3VM1116-4ED32-0AA0	3VM1116-5ED32-0AA0
200	--	3VM1220-4ED32-0AA0	3VM1220-5ED32-0AA0
250	--	3VM1225-4ED32-0AA0	3VM1225-5ED32-0AA0
NEW 320	--	3VM1332-4ED32-0AA0	3VM1332-5ED32-0AA0
400	--	3VM1340-4ED32-0AA0	3VM1340-5ED32-0AA0
NEW 500	--	3VM1450-4ED32-0AA0	3VM1450-5ED32-0AA0
630	--	3VM1463-4ED32-0AA0	3VM1463-5ED32-0AA0

3VM Molded Case Circuit Breakers up to 630 A, TM, 400 V, up to 55 kA

Line protection



Connection technology

Type

Rated current I_n

Current setting of the inverse-time delayed overload protection "L" I_r

Operating current of the instantaneous short-circuit protection "I" I_i

DT

I_{cu} up to 16 kA at 415 V, very low breaking capacity B B
See "Overview", p. 1/2

Article No. [www.siemens.com/product?Article No.](http://www.siemens.com/product?ArticleNo.)

Basic price per PU

A

A

A

3-pole, fixed-mounted, 3VM11 to 3VM14, up to 630 A Thermal-magnetic trip unit



1201_19254

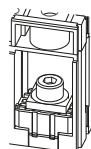
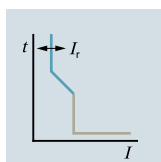

Line protection, TM220 ATFM

With adjustable overload protection I_r and fixed short-circuit protection I_i

Connection with lug terminal

3VM11	16	11 ... 16	320	--
	20	14 ... 20	320	--
	25	18 ... 25	320	--
	32	22 ... 32	320	--
	40	28 ... 40	400	--
	50	35 ... 50	500	--
3VM12	63	44 ... 63	630	--
	80	56 ... 80	800	--
	100	70 ... 100	1000	--
3VM13	125	88 ... 125	1250	--
	160	112 ... 160	1600	--
3VM14	200	140 ... 200	2000	--
	250	175 ... 250	2500	--
3VM13 NEW	320	220 ... 320	3200	--
	400	280 ... 400	4000	--
3VM14 NEW	500	350 ... 500	5000	--
	630	440 ... 630	6300	--

3VM Molded Case Circuit Breakers up to 630 A, TM, 400 V, up to 55 kA

Line protection

Rated current I_n	I_{cu} up to 25 kA at 415 V, low breaking capacity N N	DT	I_{cu} to 36 kA at 415 V, standard breaking capacity S S	DT	I_{cu} up to 55 kA at 415 V, medium breaking capacity M M	
	See "Overview", p. 1/2		See "Overview", p. 1/2		See "Overview", p. 1/2	
	Article No. www.siemens.com/ product?Article.No.	Basic price per PU	Article No. www.siemens.com/ product?Article.No.	Basic price per PU	Article No. www.siemens.com/ product?Article.No.	Basic price per PU
A						

Line protection, TM220 ATFMWith adjustable overload protection I_r and fixed short-circuit protection I_i

Connection with lug terminal			
16	3VM1196-3EE32-0AA0	3VM1196-4EE32-0AA0	3VM1196-5EE32-0AA0
20	3VM1120-3EE32-0AA0	3VM1120-4EE32-0AA0	3VM1120-5EE32-0AA0
25	3VM1125-3EE32-0AA0	3VM1125-4EE32-0AA0	3VM1125-5EE32-0AA0
32	3VM1132-3EE32-0AA0	3VM1132-4EE32-0AA0	3VM1132-5EE32-0AA0
40	3VM1140-3EE32-0AA0	3VM1140-4EE32-0AA0	3VM1140-5EE32-0AA0
50	3VM1150-3EE32-0AA0	3VM1150-4EE32-0AA0	3VM1150-5EE32-0AA0
63	3VM1163-3EE32-0AA0	3VM1163-4EE32-0AA0	3VM1163-5EE32-0AA0
80	3VM1180-3EE32-0AA0	3VM1180-4EE32-0AA0	3VM1180-5EE32-0AA0
100	3VM1110-3EE32-0AA0	3VM1110-4EE32-0AA0	3VM1110-5EE32-0AA0
125	3VM1112-3EE32-0AA0	3VM1112-4EE32-0AA0	3VM1112-5EE32-0AA0
160	3VM1116-3EE32-0AA0	3VM1116-4EE32-0AA0	3VM1116-5EE32-0AA0
200	--	3VM1220-4EE32-0AA0	3VM1220-5EE32-0AA0
250	--	3VM1225-4EE32-0AA0	3VM1225-5EE32-0AA0
NEW 320	--	3VM1332-4EE32-0AA0	3VM1332-5EE32-0AA0
NEW 400	--	3VM1340-4EE32-0AA0	3VM1340-5EE32-0AA0
500	--	3VM1450-4EE32-0AA0	3VM1450-5EE32-0AA0
630	--	3VM1463-4EE32-0AA0	3VM1463-5EE32-0AA0

3VM Molded Case Circuit Breakers up to 630 A, TM, 400 V, up to 55 kA

Line protection

PU (UNIT, SET, M) = 1

PS*/P. unit = 1 UNIT

PG = 1CB



Connection technology

Type

Rated current I_n Current setting of the inverse-time delayed overload protection "L" I_r Operating current of the instantaneous short-circuit protection "I" I_i

DT

I_{cu} up to 16 kA at 415 V, very low breaking capacity B

See "Overview", p. 1/2

B

Article No.
www.siemens.com/product?Article.No.

Basic price per PU

A

A

A

4-pole, fixed-mounted, 3VM10 to 3VM14, up to 630 A Thermal-magnetic trip unit

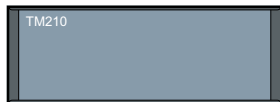

I201_19253

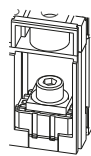
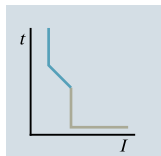

Line protection, TM210 FTFM, without neutral conductor protection

With fixed overload protection I_r and fixed short-circuit protection I_i

Connection with lug terminal

3VM	Rated current I_n	Overload protection I_r	Short-circuit protection I_i	Article No.
3VM10	16	16	320	3VM1096-2ED42-0AA0
	20	20	320	3VM1020-2ED42-0AA0
	25	25	320	3VM1025-2ED42-0AA0
	32	32	320	3VM1032-2ED42-0AA0
	40	40	400	3VM1040-2ED42-0AA0
	50	50	500	3VM1050-2ED42-0AA0
	63	63	630	3VM1063-2ED42-0AA0
	80	80	800	3VM1080-2ED42-0AA0
	100	100	1000	3VM1010-2ED42-0AA0
	3VM11	16	16	320
20		20	320	--
25		25	320	--
32		32	320	--
40		40	400	--
50		50	500	--
63		63	630	--
3VM12	200	200	2000	--
	250	250	2500	--
	320	320	3200	--
3VM13	400	400	4000	--
	630	630	6300	--

Line protection, TM210 FTFM, 100 % neutral conductor protection

With fixed overload protection I_r and fixed short-circuit protection I_i

Connection with lug terminal

3VM	Rated current I_n	Overload protection I_r	Short-circuit protection I_i	Article No.
3VM11	16	16	320	--
	20	20	320	--
	25	25	320	--
	32	32	320	--
	40	40	400	--
	50	50	500	--
	63	63	630	--
	80	80	800	--
	100	100	1000	--
	125	125	1250	--
3VM12	200	200	2000	--
	250	250	2500	--
	320	320	3200	--
3VM13	400	400	4000	--
	630	630	6300	--

3VM Molded Case Circuit Breakers up to 630 A, TM, 400 V, up to 55 kA

Line protection

PU (UNIT, SET, M) = 1

PS*/P. unit = 1 UNIT

PG = 1CB

Rated current I_n	DT	I_{cu} up to 25 kA at 415 V, low breaking capacity N (N)		I_{cu} to 36 kA at 415 V, standard breaking capacity S (S)		I_{cu} up to 55 kA at 415 V, medium breaking capacity M (M)	
		See "Overview", p. 1/2		See "Overview", p. 1/2		See "Overview", p. 1/2	
		Article No. www.siemens.com/ product?Article No.	Basic price per PU	Article No. www.siemens.com/ product?Article No.	Basic price per PU	Article No. www.siemens.com/ product?Article No.	Basic price per PU
A							

Line protection, TM210 FTFM, without neutral conductor protectionWith fixed overload protection I_r and fixed short-circuit protection I_s

Connection with lug terminal			
16	3VM1096-3ED42-0AA0	3VM1096-4ED42-0AA0	--
20	3VM1020-3ED42-0AA0	3VM1020-4ED42-0AA0	--
25	3VM1025-3ED42-0AA0	3VM1025-4ED42-0AA0	--
32	3VM1032-3ED42-0AA0	3VM1032-4ED42-0AA0	--
40	3VM1040-3ED42-0AA0	3VM1040-4ED42-0AA0	--
50	3VM1050-3ED42-0AA0	3VM1050-4ED42-0AA0	--
63	3VM1063-3ED42-0AA0	3VM1063-4ED42-0AA0	--
80	3VM1080-3ED42-0AA0	3VM1080-4ED42-0AA0	--
100	3VM1010-3ED42-0AA0	3VM1010-4ED42-0AA0	--
16	3VM1196-3ED42-0AA0	3VM1196-4ED42-0AA0	3VM1196-5ED42-0AA0
20	3VM1120-3ED42-0AA0	3VM1120-4ED42-0AA0	3VM1120-5ED42-0AA0
25	3VM1125-3ED42-0AA0	3VM1125-4ED42-0AA0	3VM1125-5ED42-0AA0
32	3VM1132-3ED42-0AA0	3VM1132-4ED42-0AA0	3VM1132-5ED42-0AA0
40	3VM1140-3ED42-0AA0	3VM1140-4ED42-0AA0	3VM1140-5ED42-0AA0
50	3VM1150-3ED42-0AA0	3VM1150-4ED42-0AA0	3VM1150-5ED42-0AA0
63	3VM1163-3ED42-0AA0	3VM1163-4ED42-0AA0	3VM1163-5ED42-0AA0
80	3VM1180-3ED42-0AA0	3VM1180-4ED42-0AA0	3VM1180-5ED42-0AA0
100	3VM1110-3ED42-0AA0	3VM1110-4ED42-0AA0	3VM1110-5ED42-0AA0
125	3VM1112-3ED42-0AA0	3VM1112-4ED42-0AA0	3VM1112-5ED42-0AA0
160	3VM1116-3ED42-0AA0	3VM1116-4ED42-0AA0	3VM1116-5ED42-0AA0
200	--	3VM1220-4ED42-0AA0	3VM1220-5ED42-0AA0
250	--	3VM1225-4ED42-0AA0	3VM1225-5ED42-0AA0
NEW 320	--	3VM1332-4ED42-0AA0	3VM1332-5ED42-0AA0
400	--	3VM1340-4ED42-0AA0	3VM1340-5ED42-0AA0
NEW 500	--	3VM1450-4ED42-0AA0	3VM1450-5ED42-0AA0
630	--	3VM1463-4ED42-0AA0	3VM1463-5ED42-0AA0

Line protection, TM210 FTFM, 100 % neutral conductor protectionWith fixed overload protection I_r and fixed short-circuit protection I_s

Connection with lug terminal			
16	3VM1196-3GD42-0AA0	3VM1196-4GD42-0AA0	3VM1196-5GD42-0AA0
20	3VM1120-3GD42-0AA0	3VM1120-4GD42-0AA0	3VM1120-5GD42-0AA0
25	3VM1125-3GD42-0AA0	3VM1125-4GD42-0AA0	3VM1125-5GD42-0AA0
32	3VM1132-3GD42-0AA0	3VM1132-4GD42-0AA0	3VM1132-5GD42-0AA0
40	3VM1140-3GD42-0AA0	3VM1140-4GD42-0AA0	3VM1140-5GD42-0AA0
50	3VM1150-3GD42-0AA0	3VM1150-4GD42-0AA0	3VM1150-5GD42-0AA0
63	3VM1163-3GD42-0AA0	3VM1163-4GD42-0AA0	3VM1163-5GD42-0AA0
80	3VM1180-3GD42-0AA0	3VM1180-4GD42-0AA0	3VM1180-5GD42-0AA0
100	3VM1110-3GD42-0AA0	3VM1110-4GD42-0AA0	3VM1110-5GD42-0AA0
125	3VM1112-3GD42-0AA0	3VM1112-4GD42-0AA0	3VM1112-5GD42-0AA0
160	3VM1116-3GD42-0AA0	3VM1116-4GD42-0AA0	3VM1116-5GD42-0AA0
200	--	3VM1220-4GD42-0AA0	3VM1220-5GD42-0AA0
250	--	3VM1225-4GD42-0AA0	3VM1225-5GD42-0AA0
NEW 320	--	3VM1332-4GD42-0AA0	3VM1332-5GD42-0AA0
400	--	3VM1340-4GD42-0AA0	3VM1340-5GD42-0AA0
NEW 500	--	3VM1450-4GD42-0AA0	3VM1450-5GD42-0AA0
630	--	3VM1463-4GD42-0AA0	3VM1463-5GD42-0AA0

3VM Molded Case Circuit Breakers up to 630 A, TM, 400 V, up to 55 kA

Line protection

PU (UNIT, SET, M) = 1

PS*/P. unit = 1 UNIT

PG = 1CB



Connection technology

Type

Rated current I_n Current setting of the inverse-time delayed overload protection "L" I_r Operating current of the instantaneous short-circuit protection "I" I_i

DT

I_{cu} up to 25 kA at 415 V, low breaking capacity N
See "Overview", p. 1/2

N

Article No.
www.siemens.com/product?Article No.

Basic price
per PU

A

A

A

4-pole, fixed-mounted, 3VM11 to 3VM14, up to 630A
Thermal-magnetic trip unit



1201_19254

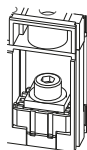
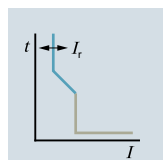

Line protection, TM220 ATFM, without neutral conductor protection

With adjustable overload protection I_r and fixed short-circuit protection I_i

Connection with lug terminal

3VM	I_n	I_r	I_i	Article No.
3VM11	16	11 ... 16	320	3VM1196-3EE42-0AA0
	20	14 ... 20	320	3VM1120-3EE42-0AA0
	25	18 ... 25	320	3VM1125-3EE42-0AA0
	32	22 ... 32	320	3VM1132-3EE42-0AA0
	40	28 ... 40	400	3VM1140-3EE42-0AA0
	50	35 ... 50	500	3VM1150-3EE42-0AA0
	63	44 ... 63	630	3VM1163-3EE42-0AA0
	80	56 ... 80	800	3VM1180-3EE42-0AA0
3VM12	100	70 ... 100	1000	3VM1110-3EE42-0AA0
	125	88 ... 125	1250	3VM1112-3EE42-0AA0
	160	112 ... 160	1600	3VM1116-3EE42-0AA0
3VM13	200	140 ... 200	2000	--
	250	175 ... 250	2500	--
3VM13 NEW	320	220 ... 320	3200	--
	400	280 ... 400	4000	--
3VM14 NEW	500	350 ... 500	5000	--
	630	440 ... 630	6300	--

Line protection, TM220 ATFM, 100 % neutral conductor protection

With adjustable overload protection I_r and fixed short-circuit protection I_i

Connection with lug terminal

3VM	I_n	I_r	I_i	Article No.
3VM11	16	11 ... 16	320	3VM1196-3GE42-0AA0
	20	14 ... 20	320	3VM1120-3GE42-0AA0
	25	18 ... 25	320	3VM1125-3GE42-0AA0
	32	22 ... 32	320	3VM1132-3GE42-0AA0
	40	28 ... 40	400	3VM1140-3GE42-0AA0
	50	35 ... 50	500	3VM1150-3GE42-0AA0
	63	44 ... 63	630	3VM1163-3GE42-0AA0
	80	56 ... 80	800	3VM1180-3GE42-0AA0
3VM12	100	70 ... 100	1000	3VM1110-3GE42-0AA0
	125	88 ... 125	1250	3VM1112-3GE42-0AA0
	160	112 ... 160	1600	3VM1116-3GE42-0AA0
3VM12	200	140 ... 200	2000	--
	250	175 ... 250	2500	--
3VM13 NEW	320	220 ... 320	3200	--
	400	280 ... 400	4000	--
3VM14 NEW	500	350 ... 500	5000	--
	630	440 ... 630	6300	--

3VM Molded Case Circuit Breakers up to 630 A, TM, 400 V, up to 55 kA

Line protection

PU (UNIT, SET, M) = 1

PS*/P. unit = 1 UNIT

PG = 1CB

Rated current I_n	DT	I_{cu} to 36 kA at 415 V, standard breaking capacity S See "Overview", p. 1/2	(S)	DT	I_{cu} up to 55 kA at 415 V, medium breaking capacity M See "Overview", p. 1/2	(M)
		Article No. www.siemens.com/ product?Article.No.	Basic price per PU		Article No. www.siemens.com/ product?Article.No.	Basic price per PU
A						

Line protection, TM220 ATFM, without neutral conductor protectionWith adjustable overload protection I_r and fixed short-circuit protection I_i

Connection with lug terminal			
16	3VM1196-4EE42-0AA0	3VM1196-5EE42-0AA0	
20	3VM1120-4EE42-0AA0	3VM1120-5EE42-0AA0	
25	3VM1125-4EE42-0AA0	3VM1125-5EE42-0AA0	
32	3VM1132-4EE42-0AA0	3VM1132-5EE42-0AA0	
40	3VM1140-4EE42-0AA0	3VM1140-5EE42-0AA0	
50	3VM1150-4EE42-0AA0	3VM1150-5EE42-0AA0	
63	3VM1163-4EE42-0AA0	3VM1163-5EE42-0AA0	
80	3VM1180-4EE42-0AA0	3VM1180-5EE42-0AA0	
100	3VM1110-4EE42-0AA0	3VM1110-5EE42-0AA0	
125	3VM1112-4EE42-0AA0	3VM1112-5EE42-0AA0	
160	3VM1116-4EE42-0AA0	3VM1116-5EE42-0AA0	
200	3VM1220-4EE42-0AA0	3VM1220-5EE42-0AA0	
250	3VM1225-4EE42-0AA0	3VM1225-5EE42-0AA0	
NEW 320	3VM1332-4EE42-0AA0	3VM1332-5EE42-0AA0	
400	3VM1340-4EE42-0AA0	3VM1340-5EE42-0AA0	
NEW 500	3VM1450-4EE42-0AA0	3VM1450-5EE42-0AA0	
630	3VM1463-4EE42-0AA0	3VM1463-5EE42-0AA0	

Line protection, TM220 ATFM, 100 % neutral conductor protectionWith adjustable overload protection I_r and fixed short-circuit protection I_i

Connection with lug terminal			
16	3VM1196-4GE42-0AA0	3VM1196-5GE42-0AA0	
20	3VM1120-4GE42-0AA0	3VM1120-5GE42-0AA0	
25	3VM1125-4GE42-0AA0	3VM1125-5GE42-0AA0	
32	3VM1132-4GE42-0AA0	3VM1132-5GE42-0AA0	
40	3VM1140-4GE42-0AA0	3VM1140-5GE42-0AA0	
50	3VM1150-4GE42-0AA0	3VM1150-5GE42-0AA0	
63	3VM1163-4GE42-0AA0	3VM1163-5GE42-0AA0	
80	3VM1180-4GE42-0AA0	3VM1180-5GE42-0AA0	
100	3VM1110-4GE42-0AA0	3VM1110-5GE42-0AA0	
125	3VM1112-4GE42-0AA0	3VM1112-5GE42-0AA0	
160	3VM1116-4GE42-0AA0	3VM1116-5GE42-0AA0	
200	3VM1220-4GE42-0AA0	3VM1220-5GE42-0AA0	
250	3VM1225-4GE42-0AA0	3VM1225-5GE42-0AA0	
NEW 320	3VM1332-4GE42-0AA0	3VM1332-5GE42-0AA0	
400	3VM1340-4GE42-0AA0	3VM1340-5GE42-0AA0	
NEW 500	3VM1450-4GE42-0AA0	3VM1450-5GE42-0AA0	
630	3VM1463-4GE42-0AA0	3VM1463-5GE42-0AA0	

3VM Molded Case Circuit Breakers up to 630 A, TM, 400 V, up to 55 kA

Starter protection

Selection and ordering data

PU (UNIT, SET, M) = 1

PS*/P. unit = 1 UNIT

PG = 1CB



Connection technology

Type

Rated current I_n Current setting of the inverse-time delayed overload protection "L" I_r Operating current of the instantaneous short-circuit protection "I" I_i

DT

 I_{cu} up to 55 kA at 415 V, medium breaking capacity M MArticle No.
[www.siemens.com/product?Article No.](http://www.siemens.com/product?ArticleNo.)

Basic price per PU

A

A

A

3-pole, fixed-mounted, 3VM11 to 3VM14, up to 500 A Magnetic trip unit



1201_19523

Starter protection, TM110M FM

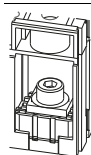
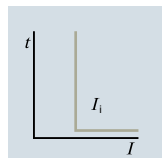
With fixed short-circuit protection I_i 

Connection with lug terminal

3VM11	8	--	128
	12.5	--	200

3VM1108-5MG32-0AA0
3VM1192-5MG32-0AA0

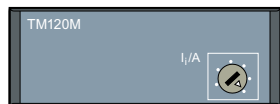

1201_19240

Starter protection, TM120M AM

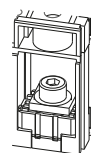
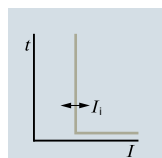
With adjustable short-circuit protection I_i 

Connection with lug terminal

3VM11	20	--	140 ... 320
	32	--	220 ... 510
	40	--	280 ... 640
	50	--	350 ... 800
	63	--	440 ... 1010
	80	--	560 ... 1280
	100	--	700 ... 1600
	125	--	875 ... 2000
3VM12	160	--	1120 ... 2560
	200	--	1200 ... 2800
3VM13 NEW	250	--	2000 ... 4000
	320	--	2240 ... 4480
3VM14 NEW	400	--	2400 ... 4800
	500	--	2500 ... 5000

3VM1120-5MH32-0AA0
3VM1132-5MH32-0AA0
3VM1140-5MH32-0AA0
3VM1150-5MH32-0AA0

3VM1163-5MH32-0AA0
3VM1180-5MH32-0AA0
3VM1110-5MH32-0AA0
3VM1112-5MH32-0AA0

3VM1216-5MH32-0AA0
3VM1220-5MH32-0AA0

3VM1325-5MH32-0AA0
3VM1332-5MH32-0AA0

3VM1440-5MH32-0AA0
3VM1450-5MH32-0AA0

3VM Molded Case Circuit Breakers up to 630 A, TM, 400 V, up to 55 kA

Switch disconnectors

Selection and ordering data

PU (UNIT, SET, M) = 1

PS*/P. unit = 1 UNIT

PG = 1CB

Connection technology	Type	Rated current I_n	DT	Article No. www.siemens.com/ product?Article No.	Basic price per PU
		A			

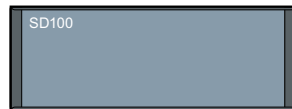
3-pole, fixed-mounted, 3VM11 to 3VM13, up to 400 A
Without trip unit**Switch disconnector SD100**

Without trip unit

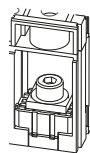
**Connection with lug terminal**

3VM11	63	3VM1163-1AA32-0AA0
	100	3VM1110-1AA32-0AA0
	125	3VM1112-1AA32-0AA0
	160	3VM1116-1AA32-0AA0
3VM12	250	3VM1225-1AA32-0AA0
3VM13 NEW	400	3VM1340-1AA32-0AA0

4-pole, fixed-mounted, up to 400 A
Without trip unit**Switch disconnector SD100**

Without trip unit

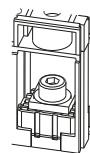
**Connection with lug terminal**

3VM11	63	3VM1163-1AA42-0AA0
	100	3VM1110-1AA42-0AA0
	125	3VM1112-1AA42-0AA0
	160	3VM1116-1AA42-0AA0
3VM12	250	3VM1225-1AA42-0AA0
3VM13 NEW	400	3VM1340-1AA42-0AA0

3VM Molded Case Circuit Breakers up to 630 A, TM, 400 V, up to 55 kA

Dimensional drawings

Overview

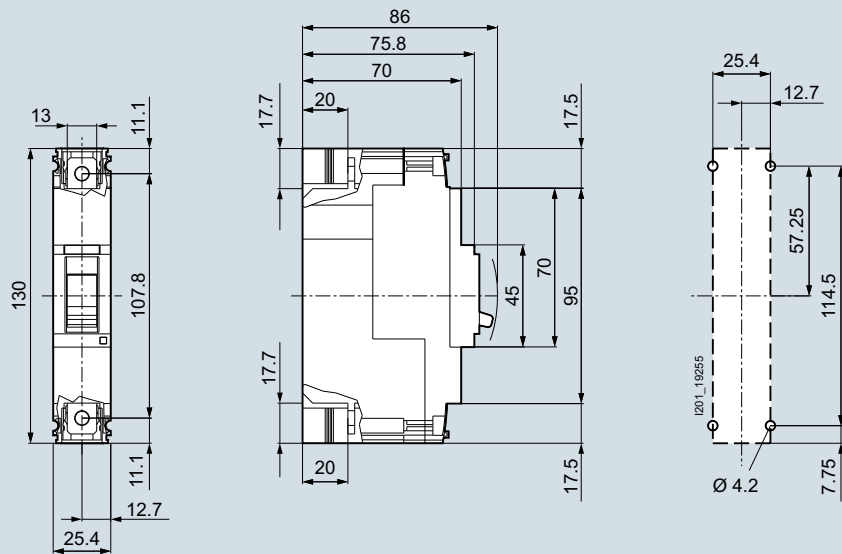

3VM11, 1-pole

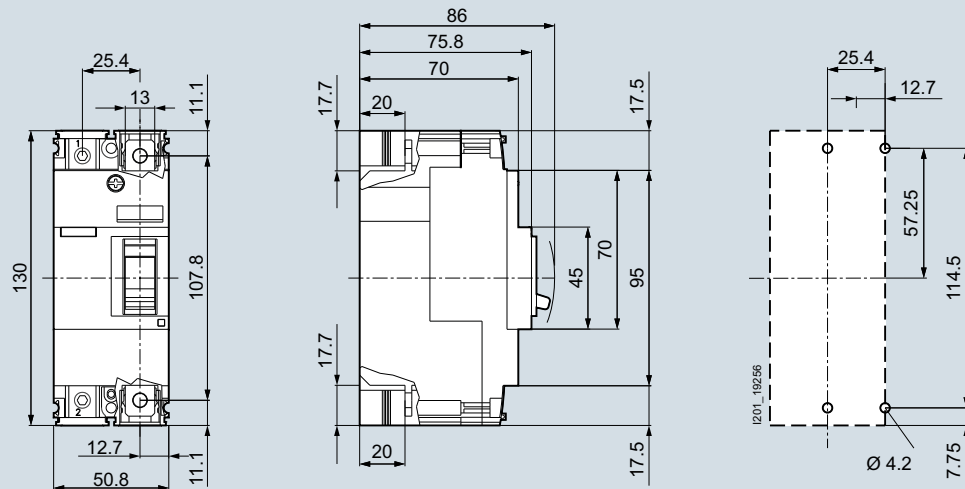

3VM11, 2-pole

3VM Molded Case Circuit Breakers up to 630 A, TM, 400 V, up to 55 kA

Dimensional drawings

Overview

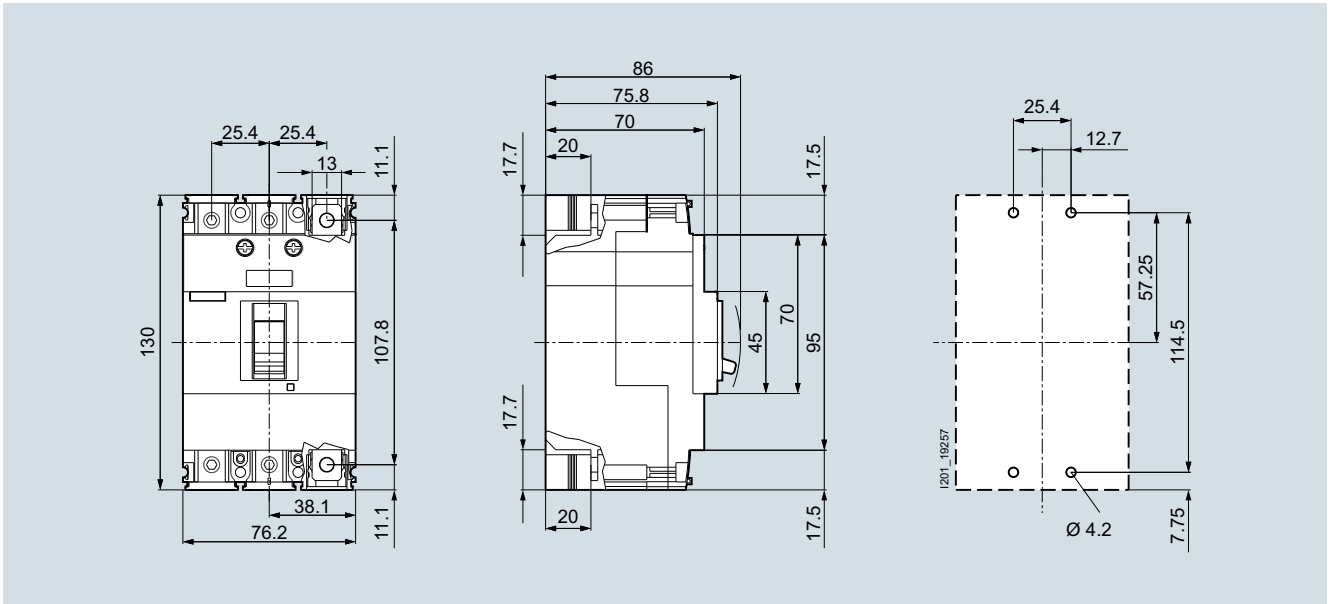

3VM10 and 3VM11, 3-pole

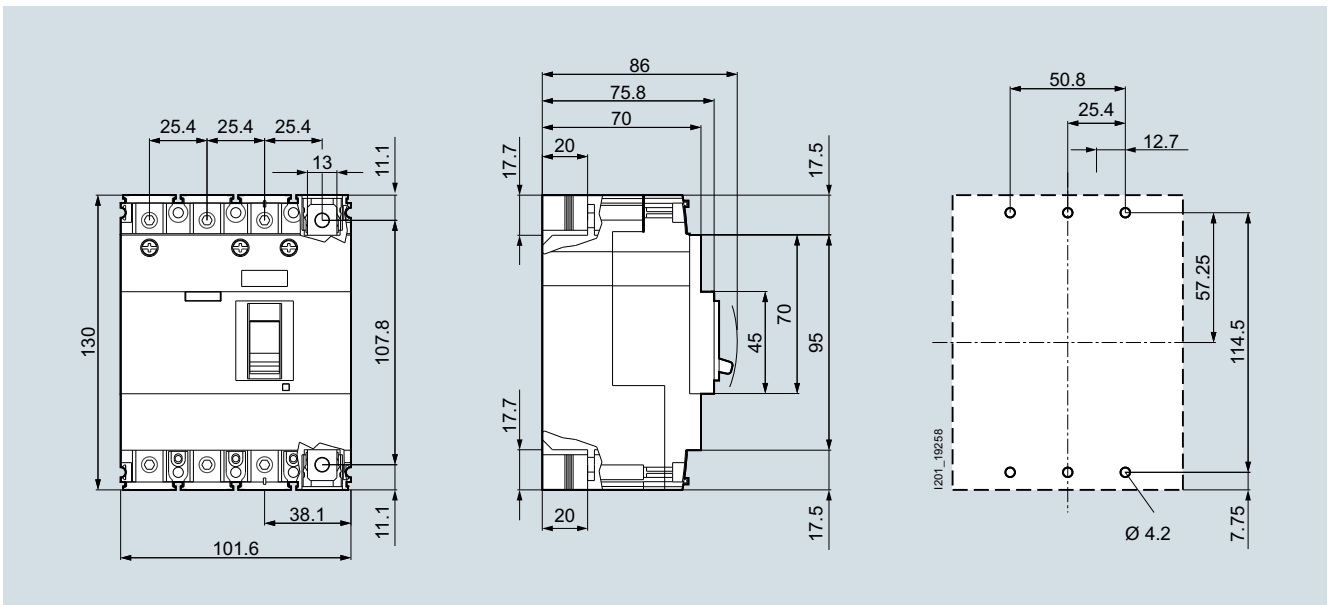

3VM10 and 3VM11, 4-pole

2

3VM Molded Case Circuit Breakers up to 630 A, TM, 400 V, up to 55 kA

Dimensional drawings

Overview

2

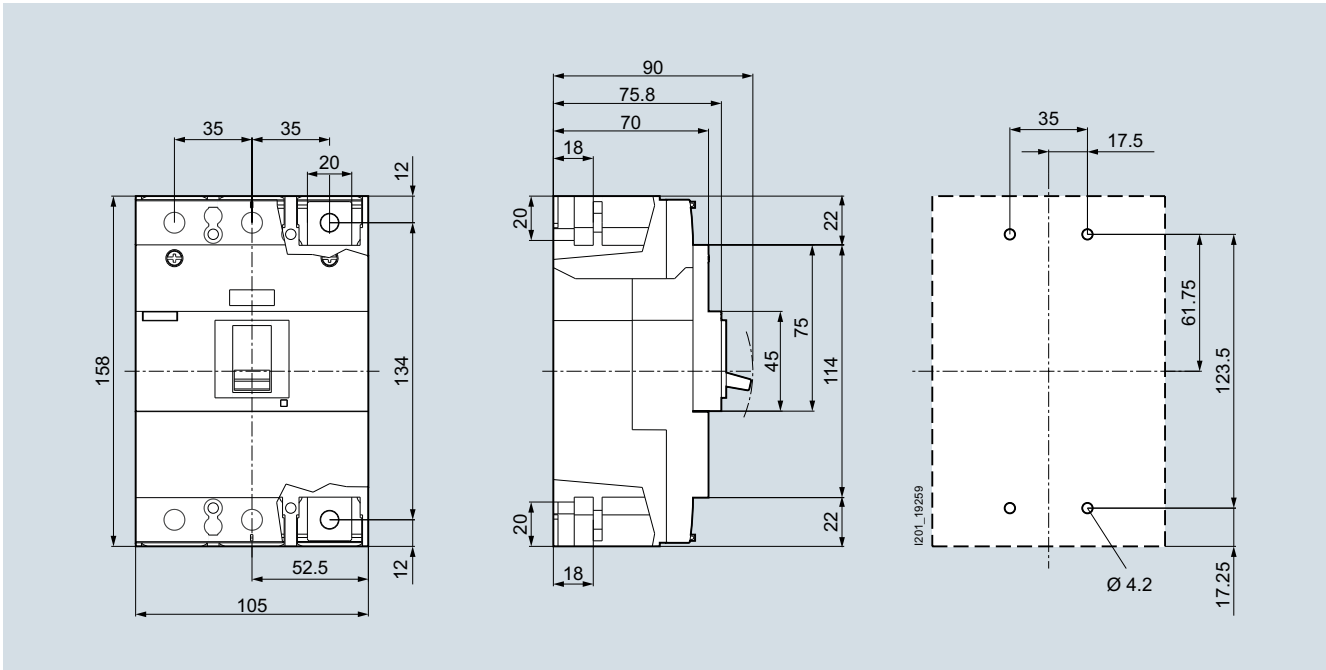

3VM12, 3-pole

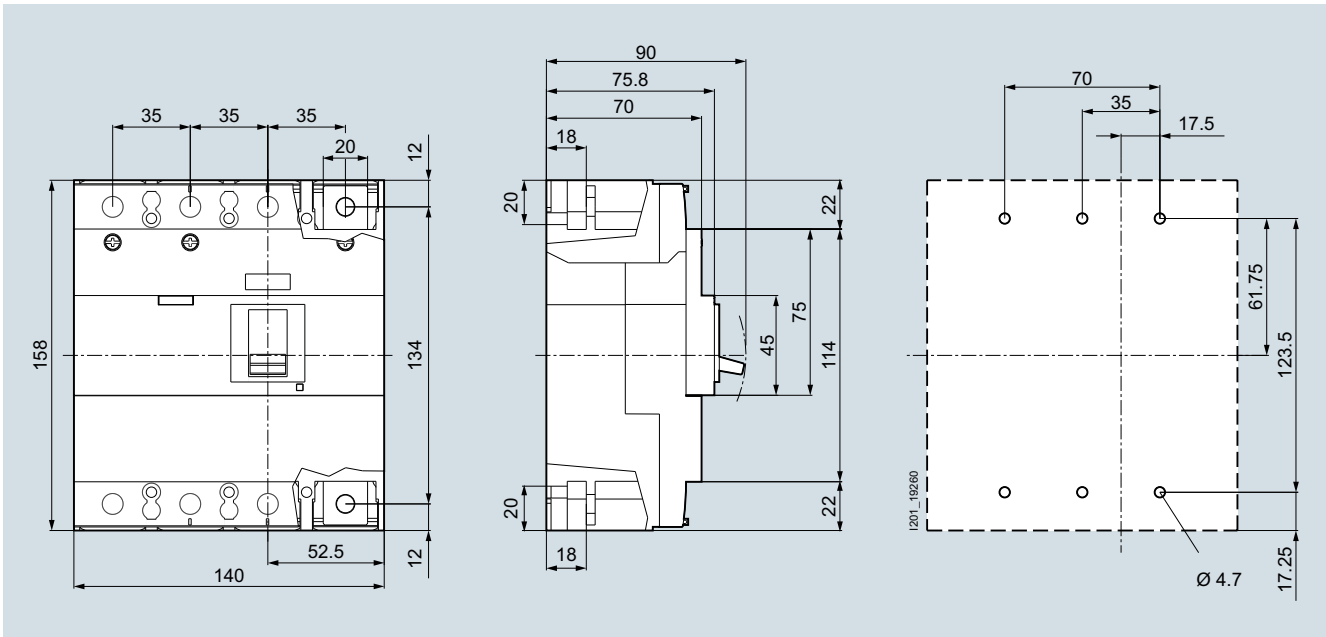

3VM12, 4-pole

3VM Molded Case Circuit Breakers up to 630 A, TM, 400 V, up to 55 kA

Dimensional drawings

2

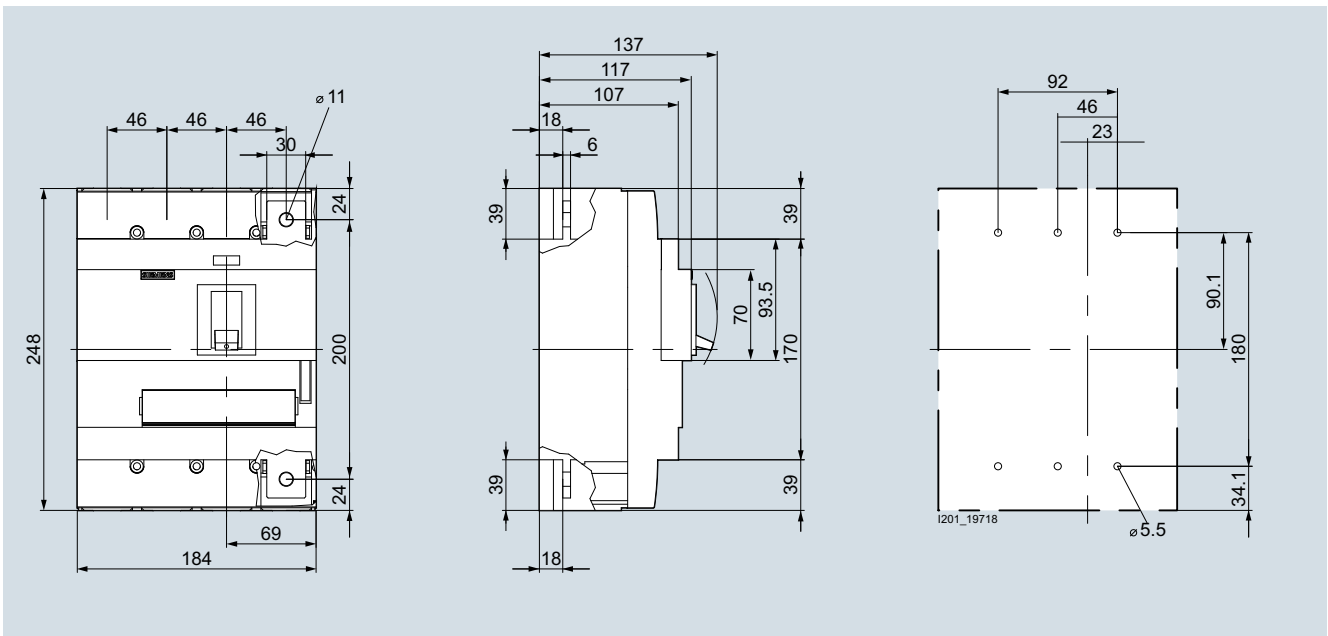
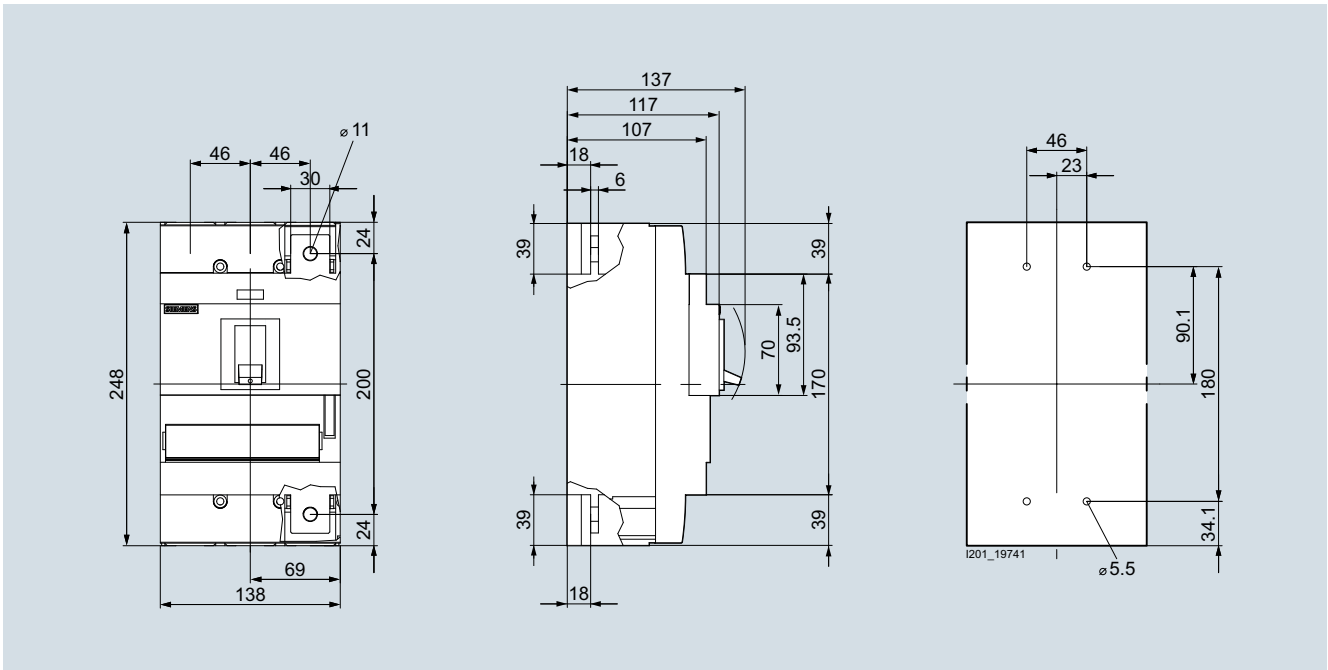

3VM Molded Case Circuit Breakers up to 630 A, TM, 400 V, up to 55 kA

Dimensional drawings

Auxiliary switches, alarm switches and position signaling contacts

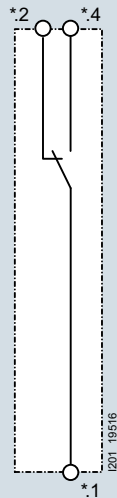

Changeover contacts for auxiliary switches AUX, trip alarm switches TAS, position signaling switches for plug-in units

Undervoltage release and shunt trip release

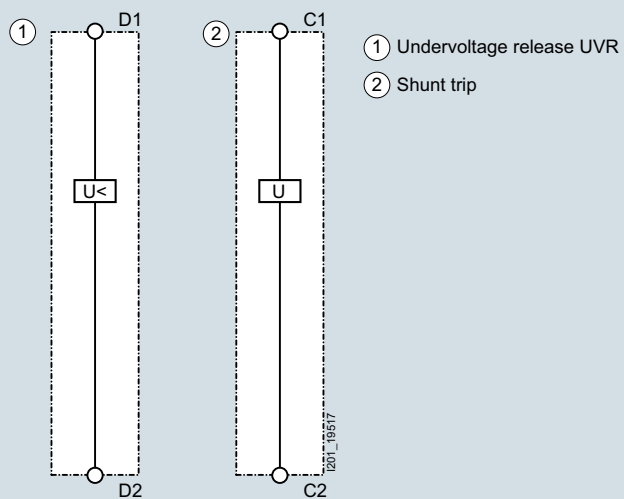

3VM Molded Case Circuit Breakers up to 630 A, TM, 400 V, up to 55 kA

Dimensional drawings

Plug-in units

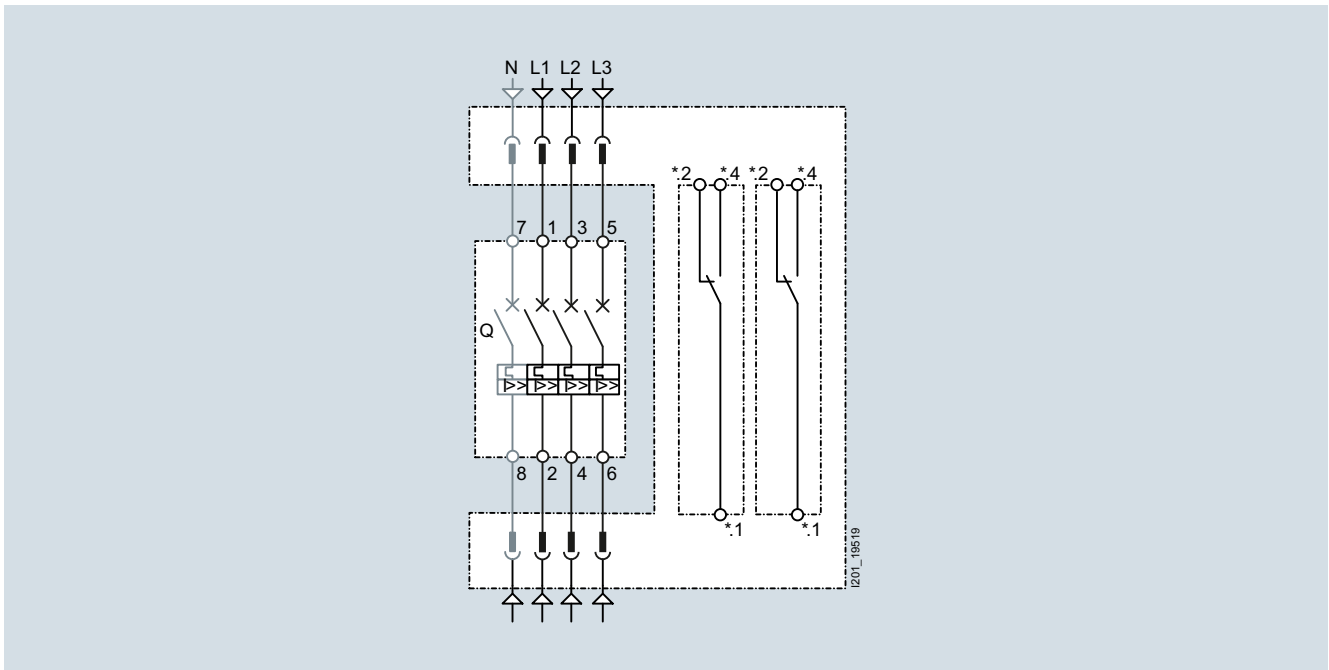

Plug-in units, 3-pole and 4-pole, with two optionally integrated position signaling switches for signaling "Plug-in unit - MCCB correctly bolted to plug-in socket"

RCD basic

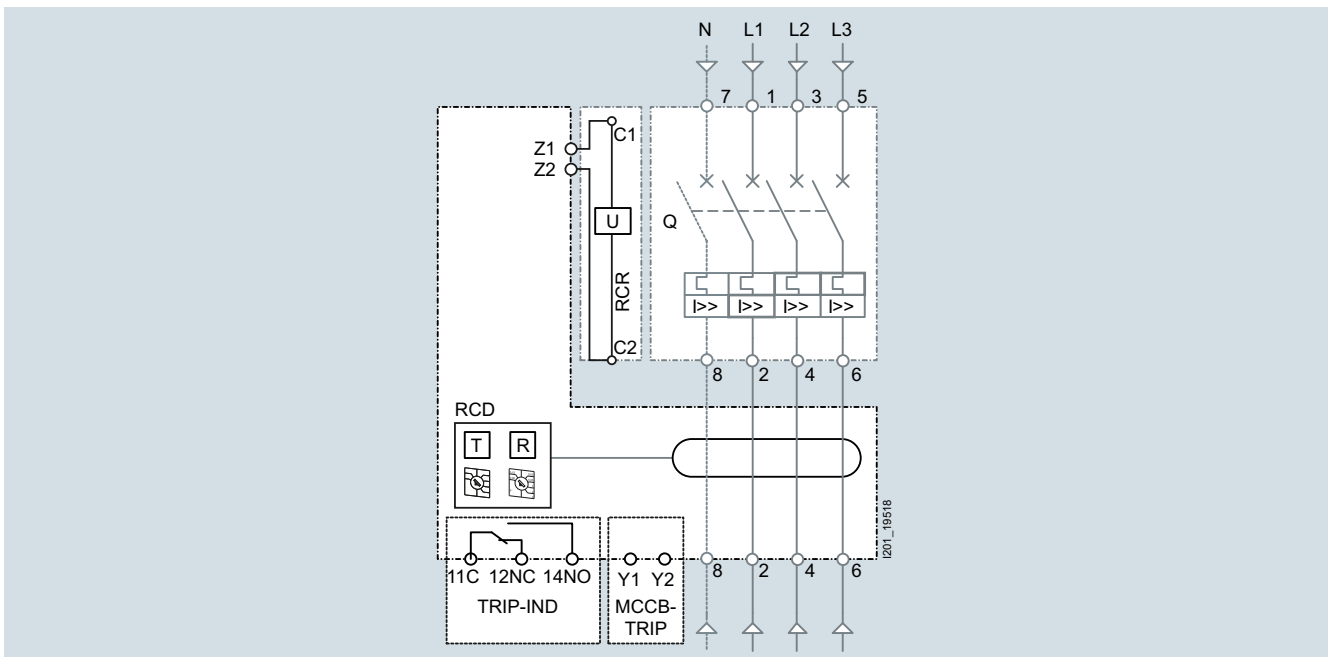

Side mounted RCD basic, 4-pole

3VM Molded Case Circuit Breakers up to 630 A, TM, 400 V, up to 55 kA

Notizen

2

Accessories and Spare Parts

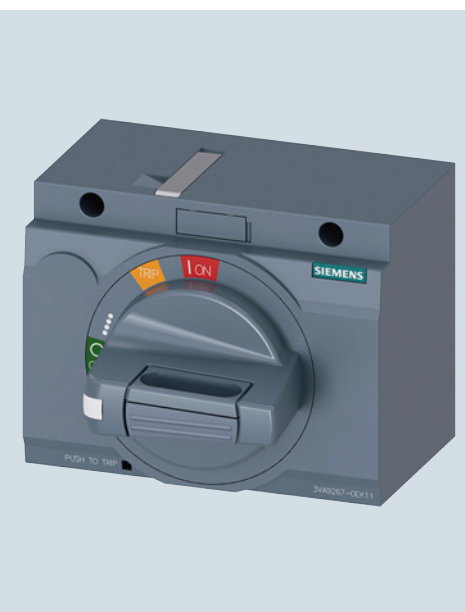

3/2	Internal accessories
3/6	Manual operators
3/9	Connection technology
3/21	Plug-in technology
3/26	Residual current devices
3/28	Locking technology
3/29	Other

For further technical product information:

Siemens Industry Online Support:
www.siemens.com/lowvoltage/product-support

→ Entry type:
 Application example
 Certificate
 Characteristic
 Download
 FAQ
 Manual
 Product note
 Software archive
 Technical data

Accessories and Spare Parts

Internal accessories

Overview

Auxiliary switches

All auxiliary and alarm switches for the 3VM molded case circuit breakers and switch disconnectors belong to an integrated range of accessories. The auxiliary switches can be simply snapped into place and connected up in the accessories compartment provided on the front face of the unit to the left and right of the handle.

The purpose of the auxiliary switches AUX is to signal the position of the main contacts of the molded case circuit breaker. The contacts of the auxiliary switches open and close simultaneously with the main contacts of the molded case circuit breaker.

Trip alarm switches TAS signal every circuit breaker tripping operation, regardless of the cause of the trip. The trip alarm switches are actuated whenever the molded case circuit breaker switches to the TRIP position.

Special electronic-compatible Versions are available for applications which require the auxiliary switch signals to be linked to automation systems.

Auxiliary releases

Auxiliary releases allow remote electrical tripping of the circuit breaker. They can be used to monitor control or main circuits in order to implement a protective system against accidental restart following a power failure, for example.

Undervoltage releases trip the 3VM molded case circuit breaker in the event that the rated voltage of a monitored circuit drops below a minimum permissible limit or fails altogether.

Shunt trips can be used to trip the 3VM molded case circuit breaker remotely.

Benefits

- The internal accessories are extremely easy to install. No tools are required because they are simply snapped into place in the accessories compartments to the left and right of the handle.
- The accessories are connected by screw terminals for auxiliary conductors with a cross-section of up to 2.5 mm². The terminals are mounted on the front of the unit for easy access.
- All auxiliary and alarm switches are designed as changeover contacts and therefore provide a high degree of flexibility for planning and installation purposes.
- Symbols engraved in the lid of the accessories compartment indicate the possible mounting positions of the internal accessories.

Design

Internal accessories Optional equipment		3VM 160 A 2-pole	3VM 100/160 A 3-pole	3VM 250 A 3-pole	3VM 400/630 A 3-pole
Slot-No:		23 22 21	23 22 21 11 12 13	24 23 22 21 11 12 13 14	25 24 23 22 21 11 12 13 14 15
Auxiliary switch	Type				
Auxiliary switch	AUX_HQ	x x x	x x x x x x	x x x x x x x x	x x x x x x x x x x
	AUX_HQ_el	x x x	x x x x x x	x x x x x x x x	x x x x x x x x x x
Alarm switch	Type				
Trip alarm switch	TAS_HQ	x x	x x x x	x x x x	x x x x
	TAS_HQ_el	x x	x x x x	x x x x	x x x x
Auxiliary release	Type				
Shunt trip left	STL	x	x	x	x
Residual current release	RCR ¹⁾				
Undervoltage release	UVR	x	x	x	x

¹⁾ Included in the scope of supply for side mounted RCDs

1201_19232



Internal accessories Optional equipment		3VM 100 A 4-pole	3VM 160 A 4-pole	3VM 250 A 4-pole	3VM 400/630 A 4-pole
Slot-No:		23 22 21 11 12 13	23 22 21 11 12 13	24 23 22 21 11 12 13 14	25 24 23 22 21 11 12 13 14 15
Auxiliary switch	Type				
Auxiliary switch	AUX_HQ	x x x x x x x	x x x x x x x	x x x x x x x x x x	x x x x x x x x x x x x
	AUX_HQ_el	x x x x x x x	x x x x x x x	x x x x x x x x x x	x x x x x x x x x x x x
Alarm switch	Type				
Trip alarm switch	TAS_HQ	x x x x	x x x x	x x x x	x x x x
	TAS_HQ_el	x x x x	x x x x	x x x x	x x x x
Auxiliary release	Type				
Shunt trip left	STL	x	x	x	x
Residual current release	RCR ¹⁾		x	x	
Undervoltage release	UVR	x	x	x	x

¹⁾ Included in the scope of supply for side mounted RCDs

1201_19233





Accessories and Spare Parts

Internal accessories

Technical specifications

				Auxiliary switches and alarm switches HQ		Auxiliary switches and alarm switches HQ_electronic	
				AUX	TAS	AUX	TAS
Width		mm		7		7	
Conductor cross-sections	Solid, stranded and finely stranded, with end sleeve	Screw connection (per contact)		1 x (0.5 - 1.5)		1 x (0.5 - 1.5)	
				1 x (AWG20 - AWG16)		1 x (AWG20 - AWG16)	
	Finely stranded with insulated end sleeve	Screw connection (per contact)		1 x (0.5 - 1.0)		1 x (0.5 - 1.0)	
				1 x (AWG20 - AWG16)		1 x (AWG20 - AWG16)	
	Tightening torque (connection cables)	Nm			0.4 ^{+0.1}		0.4 ^{+0.1}
Stripped length	mm			15		15	
Rated operating voltage		U_e	V AC 50 Hz	240		24	
			V DC	250		24	
Conventional free-air thermal current		$I_{th} = I_e$	A	6		0.3	
Rated operational current	AC-12	12 V	A	6		0.3	
		24 V	A	6		0.3	
		48 V	A	6		--	
		125 V	A	6		--	
		220/240 V	A	6		--	
		380/440 V	A	--		--	
	AC-15	12 V	A	3		0.3	
		24 V	A	3		0.3	
		48 V	A	3		--	
		125 V	A	3		--	
		220/240 V	A	3		--	
		380/440 V	A	--		--	
	DC-12	12 V	A	6		0.1	
		24 V	A	4		0.1	
		48 V	A	2		--	
		110 V	A	0.5		--	
		250 V	A	0.25		--	
	DC-13	12 V	A	1		0.07	
		24 V	A	0.8		0.07	
		48 V	A	0.4		--	
110 V		A	0.2		--		
250 V		A	0.1		--		
Minimum load	At 24 V DC		mA	70		0.5	
	At 5 V DC		mA	--		1	

Selection and ordering data

Version	DT	Article No. www.siemens.com/ product?Article No.	Price per PU	PU (UNIT, SET, M)	PS*/ P. unit	PG
Auxiliary switches and alarm switches						
 3VM9988-0AA12	Auxiliary switch AUX					
	Type/switching capacity/size	Electronic-compatible				
	HQ/compact size/1 slot	--				
	HQ_el/compact size/1 slot	✓		3VM9988-0AA12	1	1 unit 1CB
				3VM9988-0AA13	1	1 unit 1CB
 3VM9988-0AB12	Trip alarm switch TAS					
	Type/switching capacity/size	Electronic-compatible				
	HQ/compact size/1 slot	--				
	HQ_el/compact size/1 slot	✓		3VM9988-0AB12	1	1 unit 1CB
				3VM9988-0AB13	1	1 unit 1CB
Undervoltage releases						
 3VM9908-0BB15	Undervoltage release UVR					
	50/60 Hz V AC	V DC				
	--	12				
	--	24				
	--	48				
	--	60				
	--	125 ... 127				
	--	220 ... 230				
	--	250				
	24	--				
	48	--				
	60	--				
	110	--				
	120 ... 127	--				
208 ... 230	--					
380 ... 400	--					
440 ... 480	--					
				3VM9908-0BB10	1	1 unit 1CB
				3VM9908-0BB11	1	1 unit 1CB
				3VM9908-0BB12	1	1 unit 1CB
				3VM9908-0BB13	1	1 unit 1CB
				3VM9908-0BB14	1	1 unit 1CB
				3VM9908-0BB15	1	1 unit 1CB
				3VM9908-0BB16	1	1 unit 1CB
				3VM9908-0BB20	1	1 unit 1CB
				3VM9908-0BB21	1	1 unit 1CB
				3VM9908-0BB22	1	1 unit 1CB
				3VM9908-0BB23	1	1 unit 1CB
				3VM9908-0BB24	1	1 unit 1CB
				3VM9908-0BB25	1	1 unit 1CB
				3VM9908-0BB26	1	1 unit 1CB
				3VM9908-0BB27	1	1 unit 1CB
Shunt trip left						
 3VM9908-0BL33	Shunt trip left STL					
	50/60 Hz V AC	V DC				
	--	12				
	24	24 ... 30				
	48 ... 60	48 ... 60				
	110 ... 127	110 ... 127				
	208 ... 277	220 ... 250				
	380 ... 600	--				
				3VM9908-0BL10	1	1 unit 1CB
				3VM9908-0BL30	1	1 unit 1CB
				3VM9908-0BL31	1	1 unit 1CB
				3VM9908-0BL32	1	1 unit 1CB
				3VM9908-0BL33	1	1 unit 1CB
				3VM9908-0BL20	1	1 unit 1CB

Accessories and Spare Parts

Manual operators

Overview

Manual operators are provided to facilitate manual operation of the 3VM molded case circuit breakers, either directly at the circuit breaker or through the cubicle door.

Front mounted rotary operator



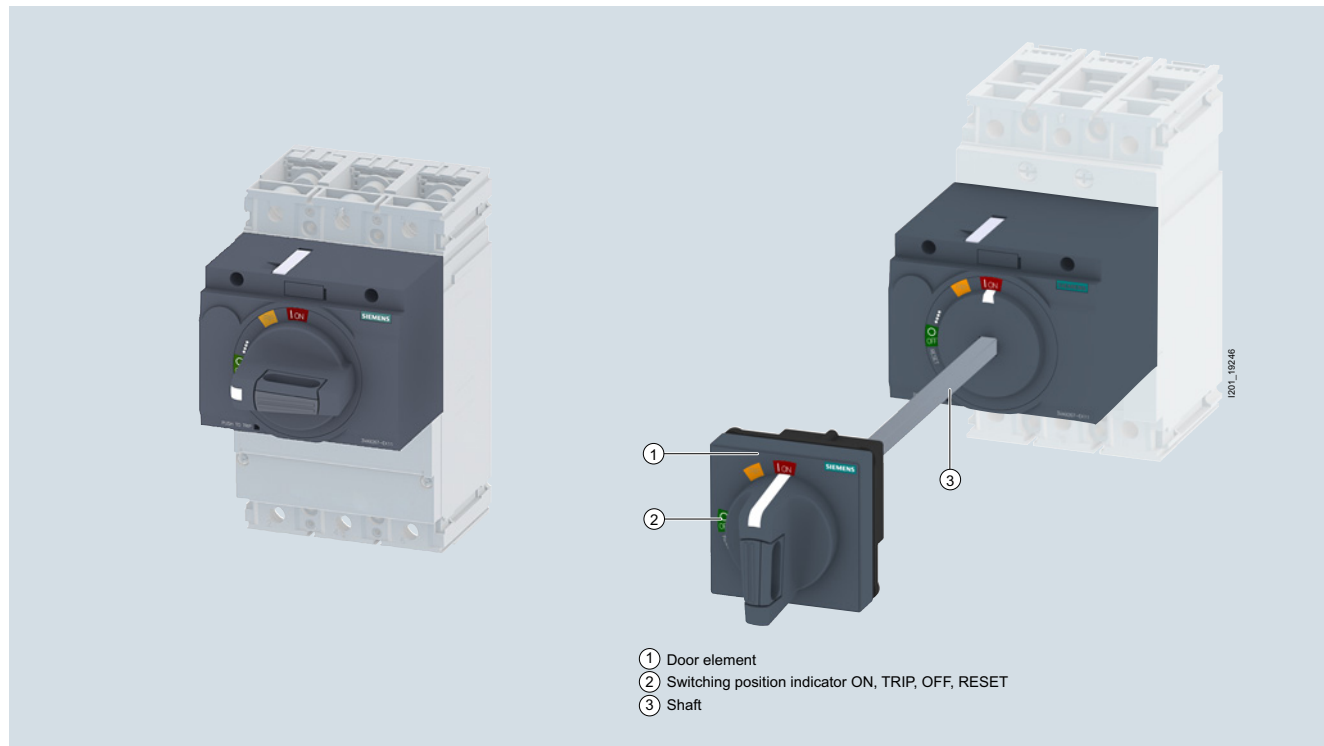

The front mounted rotary operator is mounted directly on the molded case circuit breaker and is available with or without a door interlocking system. It meets the requirements for degree of protection IP30. The door interlock locks the cubicle door when the molded case circuit breaker is closed, but can be deliberately overridden if necessary.

Door mounted rotary operator

The door mounted rotary operator enables operation of the molded case circuit breaker from the cubicle door. The door element meets the requirements for degree of protection IP65 and features a door interlocking system and tolerance compensation.



Selection and ordering data

	Version	For molded case circuit breakers/ frame size			DT	Article No. www.siemens.com/ product?Article No.	Price per PU	PU (UNIT, SET, M)	PS*/ P. unit	PG
		3VM10/ 3VM11	3VM12	3VM13/14						
Front mounted rotary operators										
 3VM9217-0EK11	Front mounted rotary operator									
	<ul style="list-style-type: none"> • For 3- and 4-pole breakers • Rotary operator • Handle • For IEC • Degree of protection IP30 									
	Type	Color								
	• Standard	gray	✓	--	--		3VM9117-0EK11	1	1 unit	1CB
			--	✓	--		3VM9217-0EK11	1	1 unit	1CB
			--	--	✓ NEW		3VM9417-0EK11	1	1 unit	1CB
	• EMERGENCY-STOP	yellow-red	✓	--	--		3VM9117-0EK15	1	1 unit	1CB
			--	✓	--		3VM9217-0EK15	1	1 unit	1CB
			--	--	✓ NEW		3VM9417-0EK15	1	1 unit	1CB
	• Standard, with door interlock	gray	✓	--	--		3VM9117-0EK21	1	1 unit	1CB
			--	✓	--		3VM9217-0EK21	1	1 unit	1CB
			--	--	✓ NEW		3VM9417-0FK21	1	1 unit	1CB
	• EMERGENCY-STOP, with door interlock	yellow-red	✓	--	--		3VM9117-0EK25	1	1 unit	1CB
			--	✓	--		3VM9217-0EK25	1	1 unit	1CB
			--	--	✓ NEW		3VM9417-0EK25	1	1 unit	1CB
Door mounted rotary operator										
 3VM9217-0FK21	Door mounted rotary operator									
	<ul style="list-style-type: none"> • for 3- and 4-pole breakers • Rotary operator • Shaft 300 mm • Mounting tolerance compensation • Handle with masking plate 75 x 75 mm • Degree of protection IP65 									
	Type	Color								
	• Standard	gray	✓	--	--		3VM9117-0FK21	1	1 unit	1CB
			--	✓	--		3VM9217-0FK21	1	1 unit	1CB
			--	--	✓ NEW		3VM9417-0FK21	1	1 unit	1CB
	• EMERGENCY-STOP	yellow-red	✓	--	--		3VM9117-0FK25	1	1 unit	1CB
			--	✓	--		3VM9217-0FK25	1	1 unit	1CB
			--	--	✓ NEW		3VM9417-0FK25	1	1 unit	1CB
	Shaft									
 8UD1900-2WB00	Shaft 8 mm									
	Versions									
	• 300 mm long		✓	✓	✓		8UD1900-2WA00	1	1 unit	1CB
	• 600 mm long		✓	✓	✓		8UD1900-2WB00	1	1 unit	1CB
Adapter for shaft 8 mm x 8 mm for door mounted rotary operator										
 8UD1900-2DA00										
			✓	✓	✓		8UD1900-2DA00	1	1 unit	1CB
Fixing bracket for shaft										
 3VM9217-0GA80										
			✓	✓	--		3VM9217-0GA80	1	1 unit	1CB
		--	--	✓ NEW		3VM9417-0GA80	1	1 unit	1CB	

Accessories and Spare Parts

Manual operators

Version	For molded case circuit breakers/ frame size			DT	Article No. www.siemens.com/ product?Article No.	Price per PU	PU (UNIT, SET, M)	PS*/ P. unit	PG
	3VM10/ 3VM11	3VM12	3VM13/14						

Handles



8UD1721-0AB11

Handles

- With masking plate

Type	Color	Tolerance com- pen- sation							
• Standard	gray	with- out	✓	✓	--	8UD1721-0AB11	1	1 unit	1CB
			--	--	✓ NEW	8UD1731-0AB11	1	1 unit	1CB
		with	✓	✓	--	8UD1721-0AB15	1	1 unit	1CB
			--	--	✓ NEW	8UD1731-0AB21	1	1 unit	1CB
• EMERGENCY-STOP	yellow- red	with- out	✓	✓	--	8UD1721-0AB15	1	1 unit	1CB
			--	--	✓ NEW	8UD1731-0AB15	1	1 unit	1CB
		with	✓	✓	--	8UD1721-0AB25	1	1 unit	1CB
			--	--	✓ NEW	8UD1731-0AB25	1	1 unit	1CB

Overview

The proper functioning and in particular the safety of electrical installations does not just depend on the quality and design of the components, but also on the method of installation.

The following aspects of electrical installations are of crucial importance for the implementation of a safe, properly functioning connection to the 3VM molded case circuit breakers:

- Installation, e.g. connection to cables or busbars
- Dimensioning of the cables and busbars
- Installation medium, e.g. rigid or flexible

The following catalog pages provide all the information needed to ensure that a 3VM molded case circuit breaker is safely connected.

Connection technology for the 3VM molded case circuit breaker

The connection technology of the 3VM molded case circuit breakers is designed to support uncomplicated and convenient commissioning of the 3VM molded case circuit breakers and to meet all installation requirements.

To meet this objective, an extensive portfolio of connection components is available.

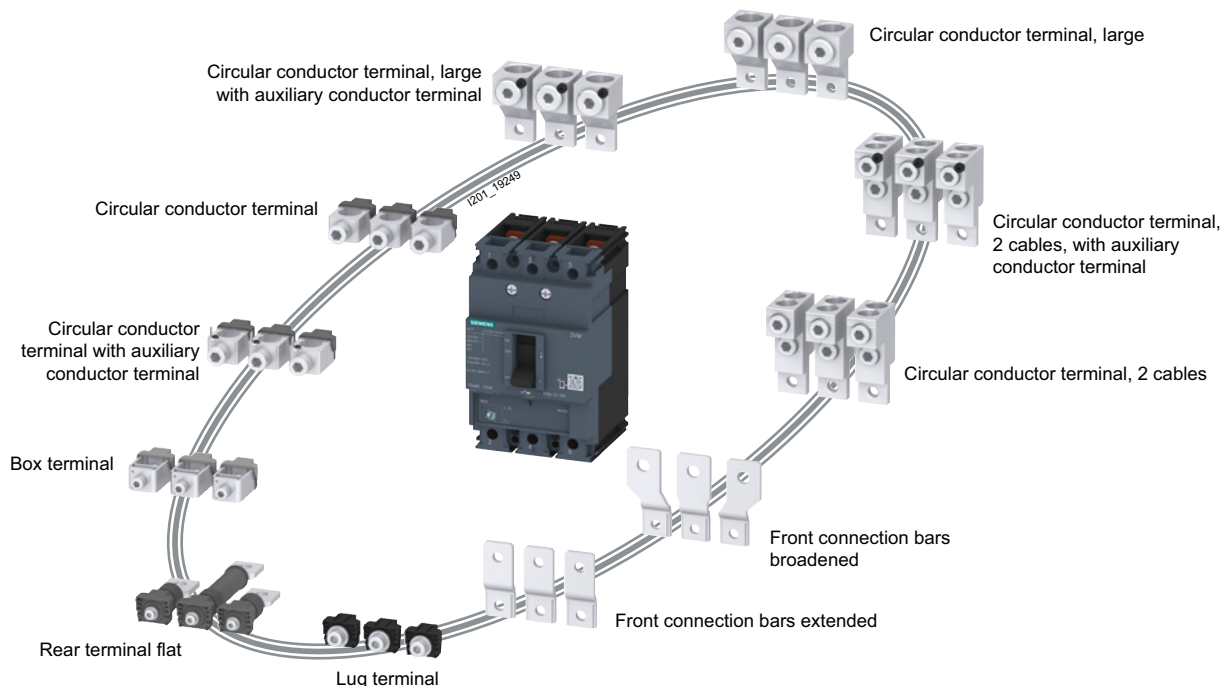

Front terminals

The portfolio of connection components for the molded case circuit breakers includes a large selection of front cable and busbar terminals.

Connection technology available from/installed at the factory

All 3VM molded case circuit breakers are available as standard with a lug terminal (clip-in nut and clamping screw) at the infeed and load ends.

Connection technology	Illustration	3VM				
		100	160	250	400	630
Lug terminal		✓	✓	✓	✓	✓

✓ Available

Insulated busbars and cables with cable lugs can be connected directly to the lug terminal. Furthermore, all connection bar extensions are assembled at the molded case circuit breaker using the lug terminal:















- Front connection bars extended (phase barriers included in scope of supply)
- Front connection bars broadened (phase barriers included in scope of supply)

The implementation of insulation measures (phase barriers or terminal covers) is recommended. With some accessory components, insulation measures are essential (and these are included in the scope of supply of the relevant component).

Accessories and Spare Parts

Connection technology

In addition to the factory-mounted connection technology included in the scope of the supply of the breaker, the following front connection components are available as accessories:

		Cable medium			
					
Front terminals	Illustration	Solid, stranded and finely stranded cables	Cable lugs	Busbars	Flexible busbars
Box terminal		✓ Cu cable	--	--	✓
Circular conductor terminal of aluminum		✓ Cu/Al cable	--	--	--
Circular conductor terminal of aluminum with auxiliary conductor terminal		✓ Cu/Al cable	--	--	--
Circular conductor terminal of aluminum, large (extended terminal cover included in scope of supply)		✓ Cu/Al cable	--	--	--
Circular conductor terminal of aluminum, large with auxiliary conductor terminal (extended terminal cover included in scope of supply)		✓ Cu/Al cable	--	--	--
Circular conductor terminal of aluminum, 2 cables (extended terminal cover included in scope of supply)		✓ Cu/Al cable	--	--	--
Circular conductor terminal of aluminum, 2 cables with auxiliary conductor terminal (extended terminal cover included in scope of supply)		✓ Cu/Al cable	--	--	--
Lug terminal		--	✓	✓	✓
Front connection bars extended (phase barriers included in scope of supply)		--	✓	✓	✓
Front connection bars broadened (phase barriers included in scope of supply)		--	✓	✓	✓





✓ Available

-- Not available

The circular conductor terminals, large and circular conductor terminals, 2cables are delivered as standard with extended terminal covers.

Rear terminals

The following connection components are available for implementing a rear terminal:

		Cable medium			
					
Rear terminals	Illustration	Solid, stranded and finely stranded cables	Cable lugs	Busbars	Flexible busbars
Rear terminal flat		--	✓	✓	✓

✓ Available

-- Not available

The rear terminal flat can be mounted at an angle in increments of 45°:

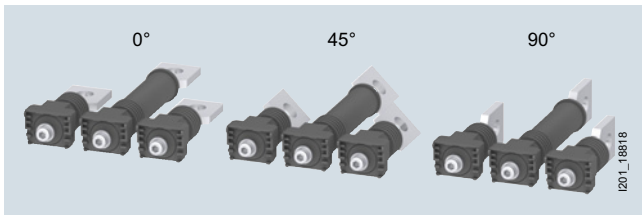

Insulated busbars and cables with cable lugs can be connected to the right-angled lug terminal. A box terminal can be mounted to allow direct connection of a cable to the right-angled lug terminal.

General note about connection technology

All connection components are available in the following sets:

- Set with 3 units
- Set with 4 units





The rear terminal is an exception as it can also be ordered individually (1 unit).

All connection systems offered for the molded case circuit breaker can be used unmodified in the plug-in technology (plug-in socket) applications.

Accessories and Spare Parts

Connection technology

Conductor cross-sections

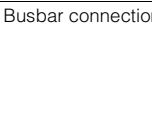
Connection technology	Cable medium	Cables and busbars	Dimensions	3VM10/11	3VM12	3VM13/14
				100 A/160 A	250 A	400 A/630 A
	Solid cable	Cu cable	mm ²	1 x 1.5 ... 16	1 x 6 ... 16	--
	Stranded cable	Cu cable	mm ²	1 x 1.5 ... 70	1 x 6 ... 120 1 x 50 ... 185	1 x 35 ... 300 ¹⁾
	Finely stranded cable	Cu cable	mm ²	1 x 1.5 ... 50	1 x 10 ... 95 1 x 95 ... 150	1 x 25 ... 240 ¹⁾
	Finely stranded with insulated end sleeve	Cu cable	mm ²	1 x 1.5 ... 50	1 x 6 ... 95 1 x 50 ... 150	1 x 25 ... 240 ¹⁾
	Flexible copper busbar	Flexible busbar	mm x mm	1 x 2x ..6 x [13 x 0.5] ... 1 x 2x ..9x [9 x 0.8]	1 x 2x .. 6x [13 x 0.5] ... 1 x 2x .. 6x [15.5 x 0.8] ... 1 x 2x .. 6x [20 x 1]	1 x 2 ... 10x [20 x 1]... 1 x 2x ... 10x [24 x 1]
	Solid cable	Cu/Al cable	mm ²	1 x 2.5/4 ... 16	--	--
	Stranded cable	Cu/Al cable	mm ²	1 x 1.5/4 ... 95	1 x 35 ... 185	1 x 50 ... 300 ¹⁾
	Finely stranded cable	Cu cable	mm ²	1 x 1.5 ... 35	1 x 35 ... 150	1 x 50 ... 240 ¹⁾
	Finely stranded with insulated end sleeve	Cu cable	mm ²	1 x 1.5 ... 35	1 x 35 ... 150	1 x 50 ... 240 ¹⁾
	Solid cable		mm ²	--	--	--
	Stranded cable	Cu/Al cable	mm ²	1 x 25 ... 150	1 x 50 ... 240	--
	Finely stranded cable	Cu cable	mm ²	1 x 25 ... 120	1 x 50 ... 185	--
	Finely stranded with insulated end sleeve	Cu cable	mm ²	1 x 25 ... 95	1 x 50 ... 185	--
	Solid cable		mm ²	--	--	--
	Stranded cable	Cu/Al cable	mm ²	--	2 x 25 ... 150	2 x 70 ... 300
	Finely stranded cable	Cu cable	mm ²	--	2 x 25 ... 150	2 x 70 ... 240
	Finely stranded with insulated end sleeve	Cu cable	mm ²	--	2 x 25 ... 70	2 x 70 ... 185
	Direct (width x height)	Busbar	mm x mm	17 x 6.5	25 x 8	35 x 10
	Front connection bars extended	Busbar	mm x mm	22 x 8	32 x 10	40 x 12.5
	Front connection bars broadened	Busbar	mm x mm	30 x 8	35 x 10	60 x 12.5

¹⁾only approved up to $I_n = 400$ A

Further connection accessoriesInsulation / auxiliary conductor connections

The connection accessories portfolio includes an extensive selection of insulating components (phase barriers, terminal covers, etc.). Auxiliary conductor connections for box terminals and busbars are also available.

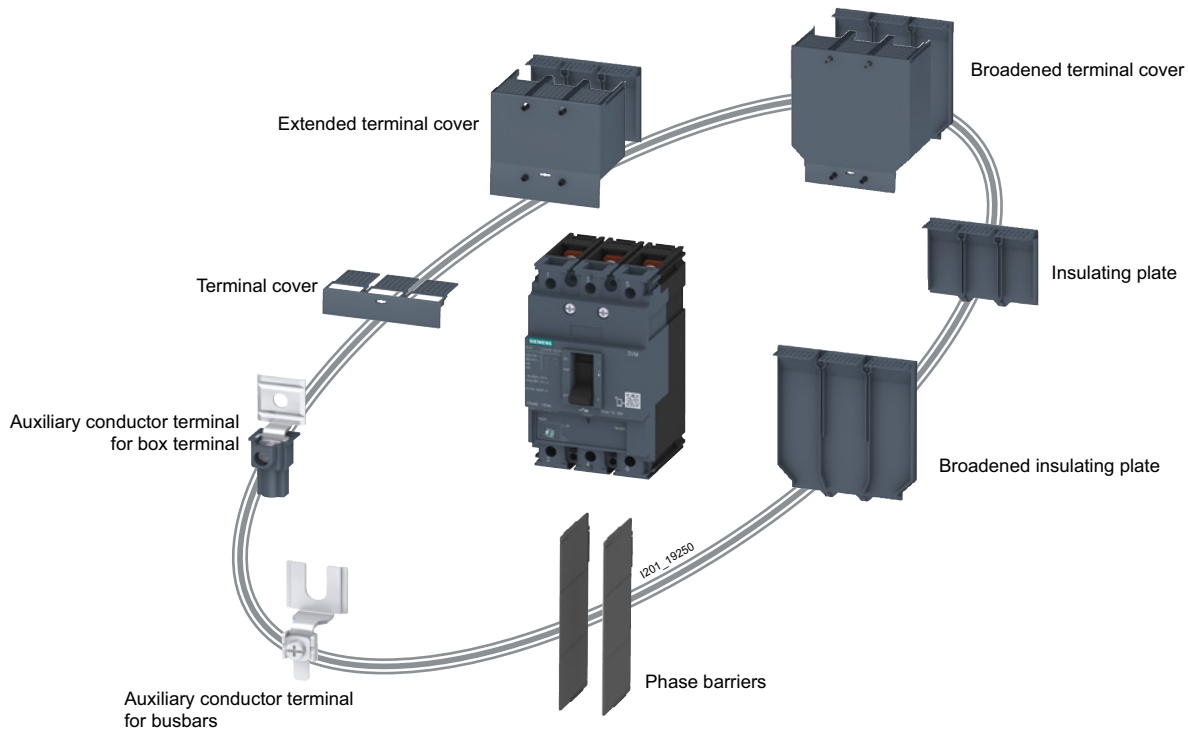
Terminal covers

Terminal covers are insulating and sealable insulation accessories which protect against accidental contact with main current paths. When mounted on the circuit breaker, terminal covers at the front provide degree of protection IP4x and when correctly installed at the infeed and load ends of the breaker, degree of protection IP2x. All terminal covers have a recess on the inside face which can be drilled out if necessary so that safe isolation can be afforded by commercially available voltage detectors.

- Short terminal covers are normally installed for all types of front termination which do not exceed the geometric dimensions of the molded case circuit breaker (the termination area) (e.g. box terminal, lug terminal, etc.).
- Extended terminal covers are required when bar extensions or external terminals (i.e. terminals which exceed the dimensions of the termination area of the molded case circuit breaker) are installed. The extended terminal cover consists of two parts, an insulating plate and the top half of the terminal cover. Both parts are attached by screws and thus afford the degrees of protection specified above.
- Broad terminal covers are required when broadened connection bars are installed. The extended terminal cover consists of two parts, a broadened insulating plate and the top half of the terminal cover. Both parts are attached by screws and thus afford the degrees of protection specified above.

Insulating plates

The purpose of insulating plates is to insulate the main terminals of the molded case circuit breaker from the mounting plate (cubicle).

- Insulating plate: in combination with bar extensions, for example
- Insulating plate broadened: in combination with broadened connection bars, for example

Auxiliary conductor terminals

All circular conductor terminals can be ordered with or without auxiliary conductor terminal (see page 3/10, *Front terminals*). The following accessories are available to allow the implementation of an auxiliary conductor terminal in combination with a box terminal or busbar connection:

- Auxiliary conductor terminal for box terminal: This terminal is fastened by screws in the box terminal with the cable.
- Auxiliary conductor terminal for busbars: This terminal is attached by screws directly to the busbar.

All auxiliary conductor terminals are rated for a maximum load of 6 A. Cables of up to 2.5 mm² can be connected.



Benefits

- High degree of flexibility
- Cables and busbars can be connected quickly and easily to the 3VM molded case circuit breaker
- Extensive selection of connection accessories

Accessories and Spare Parts







Connection technology

Selection and ordering data

	Version	Minimum mm ² for stranded cable	Maximum mm ² for stranded cable	For molded case circuit breakers/ frame size			DT	Article No. www.siemens.com/product?Article No.	Price per PU	PU (UNIT, SET, M)	PS*/ P. unit	PG
				3VM 10/11	3VM 12	3VM 13/14						
Box terminals suitable for all installation types (fixed mounted and plug-in version)												
 3VM9253-OJA12	Box terminal • Connection of Cu cable • Included in scope of supply: 3 single terminals	1.5 mm ²	70 mm ²	✓	--	--		3VM9153-OJA11		1	1 unit	1CB
		6 mm ²	120 mm ²	--	✓	--		3VM9253-OJA11		1	1 unit	1CB
		50 mm ²	185 mm ²	--	✓	--		3VM9253-OJA12		1	1 unit	1CB
		35 mm ²	300 mm ²	--	--	✓ ¹⁾	NEW	3VM9483-OJA13		1	1 unit	1CB
 3VM9254-OJA12	Box terminal • Connection of Cu cable • Included in scope of supply: 4 single terminals	1.5 mm ²	70 mm ²	✓	--	--		3VM9154-OJA11		1	1 unit	1CB
		6 mm ²	120 mm ²	--	✓	--		3VM9254-OJA11		1	1 unit	1CB
		50 mm ²	185 mm ²	--	✓	--		3VM9254-OJA12		1	1 unit	1CB
		35 mm ²	300 mm ²	--	--	✓ ¹⁾	NEW	3VM9484-OJA13		1	1 unit	1CB
Wire connectors suitable for all installation types (fixed mounted and plug-in version)												
 3VM9113-OJB11	Circular conductor terminal • Connection of Cu/Al cable • Included in scope of supply: 3 single terminals	1.5 mm ²	95 mm ²	✓	--	--		3VM9113-OJB11		1	1 unit	1CB
		35 mm ²	185 mm ²	--	✓	--		3VM9253-OJB12		1	1 unit	1CB
		50 mm ²	300 mm ²	--	--	✓ ¹⁾		3VM9383-OJB13				
 3VM9114-OJB11	Circular conductor terminal • Connection of Cu/Al cable • Included in scope of supply: 4 single terminals	1.5 mm ²	95 mm ²	✓	--	--		3VM9114-OJB11		1	1 unit	1CB
		35 mm ²	185 mm ²	--	✓	--		3VM9254-OJB12		1	1 unit	1CB
		50 mm ²	300 mm ²	--	--	✓ ¹⁾	NEW	3VM9384-OJB13		1	1 unit	1CB
 3VM9113-OJG11	Circular conductor terminal with auxiliary conductor terminal • Connection of Cu/Al cable • Included in scope of supply: 3 single terminals	1.5 mm ²	95 mm ²	✓	--	--		3VM9113-OJG11		1	1 unit	1CB
		35 mm ²	185 mm ²	--	✓	--		3VM9253-OJG12		1	1 unit	1CB
		50 mm ²	300 mm ²	--	--	✓ ¹⁾	NEW	3VM9383-OJG13				
 3VM9114-OJG11	Circular conductor terminal with auxiliary conductor terminal • Connection of Cu/Al cable • Included in scope of supply: 4 single terminals	1.5 mm ²	95 mm ²	✓	--	--		3VM9114-OJG11		1	1 unit	1CB
		35 mm ²	185 mm ²	--	✓	--		3VM9254-OJG12		1	1 unit	1CB
		50 mm ²	300 mm ²	--	--	✓ ¹⁾	NEW	3VM9383-OJG13		1	1 unit	1CB
 3VM9112-OJJ12	Circular conductor terminal, large • Connection of Cu/Al cable • Included in scope of supply: 2 single terminals and 1 extended terminal cover, 1 insulating plate	25 mm ²	150 mm ²	✓	--	--		3VM9112-OJJ12		1	1 unit	1CB
		50 mm ²	240 mm ²	--	✓	--		3VM9213-OJJ13		1	1 unit	1CB
 3VM9113-OJJ12	Circular conductor terminal, large • Connection of Cu/Al cable • Included in scope of supply: 3 single terminals and 1 extended terminal cover, 1 insulating plate	25 mm ²	150 mm ²	✓	--	--		3VM9113-OJJ12		1	1 unit	1CB
		50 mm ²	240 mm ²	--	✓	--		3VM9213-OJJ13		1	1 unit	1CB





¹⁾only approved up to $I_n = 400$ A







Connection technology

	Version	Minimum mm ² for stranded cable	Maximum mm ² for stranded cable	For molded case circuit breakers/ frame size			DT	Article No. www.siemens.com/product?Article.No.	Price per PU	PU (UNIT, SET, M)	PS*/ P. unit	PG
				3VM 10/11	3VM 12	3VM 13/14						
 3VM9114-0JJ12	Circular conductor terminal, large • Connection of Cu/Al cable • Included in scope of supply: 4 single terminals and 1 extended terminal cover, 1 insulating plate	25 mm ²	150 mm ²	✓	--	--	3VM9114-0JJ12		1	1 unit	1CB	
		50 mm ²	240 mm ²	--	✓	--						3VM9214-0JJ13
 3VM9112-0JC12	Circular conductor terminal, large, with auxiliary conductor terminal • Connection of Cu/Al cable • Included in scope of supply: 2 single terminals and 1 extended terminal cover, 1 insulating plate	25 mm ²	150 mm ²	✓	--	--	3VM9112-0JC12		1	1 unit	1CB	
 3VM9113-0JC12	Circular conductor terminal, large, with auxiliary conductor terminal • Connection of Cu/Al cable • Included in scope of supply: 3 single terminals and 1 extended terminal cover, 1 insulating plate	25 mm ²	150 mm ²	✓	--	--	3VM9113-0JC12		1	1 unit	1CB	
		50 mm ²	240 mm ²	--	✓	--	3VM9213-0JC13	1	1 unit	1CB		
 3VM9114-0JC12	Circular conductor terminal, large, with auxiliary conductor terminal • Connection of Cu/Al cable • Included in scope of supply: 4 single terminals and 1 extended terminal cover, 1 insulating plate	25 mm ²	150 mm ²	✓	--	--	3VM9114-0JC12		1	1 unit	1CB	
		50 mm ²	240 mm ²	--	✓	--	3VM9214-0JC13	1	1 unit	1CB		
 3VM9213-0JJ22	Circular conductor terminal, 2 cables • Connection of Cu/Al cable • Included in scope of supply: 3 single terminals and 1 extended terminal cover, 1 insulating plate	2 x 25 mm ²	2 x 150 mm ²	--	✓	--	3VM9213-0JJ22		1	1 unit	1CB	
		2 x 70 mm ²	2 x 300 mm ²	--	--	✓	NEW	3VM9403-0JJ23	1	1 unit	1CB	
 3VM9214-0JJ22	Circular conductor terminal, 2 cables • Connection of Cu/Al cable • Included in scope of supply: 4 single terminals and 1 extended terminal cover, 1 insulating plate	2 x 25 mm ²	2 x 150 mm ²	--	✓	--	3VM9214-0JJ22		1	1 unit	1CB	
		2 x 70 mm ²	2 x 300 mm ²	--	--	✓	NEW	3VM9404-0JJ23	1	1 unit	1CB	

Accessories and Spare Parts

Connection technology

	Version	Minimum mm ² for stranded cable	Maximum mm ² for stranded cable	For molded case circuit breakers/ frame size			DT	Article No. www.siemens.com/ product?Article No.	Price per PU	PU (UNIT, SET, M)	PS*/ P. unit	PG
				3VM 10/11	3VM 12	3VM 13/14						
  3VM9213-0JC22	Circular conductor terminal, 2 cables, with auxiliary conductor terminal <ul style="list-style-type: none"> • Connection of Cu/Al cable • Included in scope of supply: 3 single terminals and 1 extended terminal cover, 1 insulating plate 	2 x 25 mm ²	2 x 150 mm ²	--	✓	--	3VM9213-0JC22		1	1 unit	1CB	
		2 x 70 mm ²	2 x 300 mm ²	--	--	✓ NEW						3VM9403-0JC23
  3VM9214-0JC22	Circular conductor terminal, 2 cables, with auxiliary conductor terminal <ul style="list-style-type: none"> • Connection of Cu/Al cable • Included in scope of supply: 4 single terminals and 1 extended terminal cover, 1 insulating plate 	2 x 25 mm ²	2 x 150 mm ²	--	✓	--	3VM9214-0JC22		1	1 unit	1CB	
		2 x 70 mm ²	2 x 300 mm ²	--	--	✓ NEW						3VM9403-0JC23









Version	Max. terminal width	Max. busbar thickness	For molded case circuit breakers/ frame size			DT	Article No. www.siemens.com/product?Article.No.	Price per PU	PU (UNIT, SET, M)	PS* P. unit	PG
			3VM 10/11	3VM 12	3VM 13/14						
Nut keeper kits suitable for all installation types (fixed-mounted and plug-in version)											
 3VM9113-0QA00	Lug terminal Included in scope of supply: • 3 single terminals	17 mm	6.5 mm	✓	--	--	3VM9113-0QA00		1	1 unit	1CB
		25 mm	8 mm	--	✓	--	3VM9213-0QA00		1	1 unit	1CB
		35 mm	10 mm	--	--	✓ NEW	3VM9403-0QA00		1	1 unit	1CB
 3VM9114-0QA00	Lug terminal Included in scope of supply: • 4 single terminals	17 mm	6.5 mm	✓	--	--	3VM9114-0QA00		1	1 unit	1CB
		25 mm	8 mm	--	✓	--	3VM9214-0QA00		1	1 unit	1CB
		35 mm	10 mm	--	--	✓ NEW	3VM9404-0QA00		1	1 unit	1CB
Bus connectors extended specially for fixed-mounted version											
 3VM9151-0QB00	Front bus connectors extended Included in scope of supply: • 1 single terminal 1-pole version only	22 mm	8 mm	✓	--	--	3VM9151-0QB00		1	1 unit	1CB
Bus connectors extended suitable for all installation types (fixed-mounted and plug-in version)											
 3VM9253-0QB00	Front connection bars extended Included in scope of supply: • 3 single terminals • 2 phase barriers	22 mm	8 mm	✓	--	--	3VM9153-0QB00		1	1 unit	1CB
		32 mm	10 mm	--	✓	--	3VM9253-0QB00		1	1 unit	1CB
		40 mm	12.5 mm	--	--	✓ NEW	3VM9483-0QB00		1	1 unit	1CB
 3VM9254-0QB00	Front connection bars extended Included in scope of supply: • 4 single terminals • 3 phase barriers	22 mm	8 mm	✓	--	--	3VM9154-0QB00		1	1 unit	1CB
		32 mm	10 mm	--	✓	--	3VM9254-0QB00		1	1 unit	1CB
		40 mm	12.5 mm	--	--	✓ NEW	3VM9484-0QB00		1	1 unit	1CB
 3VM9253-0QC00	Front connection bars broadened Included in scope of supply: • 3 single terminals • 2 phase barriers	30 mm	8 mm	✓	--	--	3VM9153-0QC00		1	1 unit	1CB
		35 mm	10 mm	--	✓	--	3VM9253-0QC00		1	1 unit	1CB
		60 mm	12.5 mm	--	--	✓ NEW	3VM9483-0QC00		1	1 unit	1CB
Note		Distance between pole centers: • 100/160 A = 35 mm • 250 A = 45 mm • 400/630 A = 70 mm									
 3VM9254-0QC00	Front connection bars broadened Included in scope of supply: • 4 single terminals • 3 phase barriers	30 mm	8 mm	✓	--	--	3VM9154-0QC00		1	1 unit	1CB
		35 mm	10 mm	--	✓	--	3VM9254-0QC00		1	1 unit	1CB
		60 mm	12.5 mm	--	--	✓ NEW	3VM9484-0QC00		1	1 unit	1CB
Note		Distance between pole centers: • 100/160 A = 35 mm • 250 A = 45 mm • 400/630 A = 70 mm									

Accessories and Spare Parts

Connection technology





	Version	For molded case circuit breakers/ frame size			DT	Article No. www.siemens.com/ product?Article.No.	Price per PU	PU (UNIT, SET, M)	PS*/ P. unit	PG
		3VM 10/11	3VM 12	3VM 13/14						
Rear connection studs flat suitable for all installation types (fixed-mounted and plug-in versions)										
 3VM9213-0QE00	Rear terminal flat Included in scope of supply: • 2 short terminals flat • 1 long terminal flat	✓	--	--		3VM9113-0QE00		1	1 unit	1CB
		--	✓	--		3VM9213-0QE00		1	1 unit	1CB
		--	--	✓ NEW		3VM9403-0QE00		1	1 unit	1CB
 3VM9214-0QE00	Rear terminal flat Included in scope of supply: • 2 short terminals flat • 2 long terminals flat	✓	--	--		3VM9114-0QE00		1	1 unit	1CB
		--	✓	--		3VM9214-0QE00		1	1 unit	1CB
		--	--	✓ NEW		3VM9404-0QE00		1	1 unit	1CB
 3VM9211-0QE10	Rear terminal flat Included in scope of supply: • 1 short terminal flat	✓	--	--		3VM9111-0QE10		1	1 unit	1CB
		--	✓	--		3VM9211-0QE10		1	1 unit	1CB
		--	--	✓ NEW		3VM9401-0QE10		1	1 unit	1CB
 3VM9211-0QE20	Rear terminal flat Included in scope of supply: • 1 long terminal flat	✓	--	--		3VM9111-0QE20		1	1 unit	1CB
		--	✓	--		3VM9211-0QE20		1	1 unit	1CB
		--	--	✓ NEW		3VM9401-0QE20		1	1 unit	1CB
Phase barriers suitable for all installation types (fixed-mounted and plug-in versions)										
 3VM9252-0WA00	Phase barriers Included in scope of supply: • 2 phase barriers	✓	--	--		3VM9152-0WA00		1	1 unit	1CB
		--	✓	--		3VM9252-0WA00		1	1 unit	1CB
		--	--	✓ NEW		3VM9482-0WA00		1	1 unit	1CB
Terminal covers specially for fixed mounted versions										
 3VM9111-0WD10	Terminal cover for 1-pole breakers	✓	--	--		3VM9111-0WD10		1	1 unit	1CB
		only for 160 A								
 3VM9111-0WD20	Terminal cover for 2-pole breakers	✓	--	--		3VM9111-0WD20		1	1 unit	1CB
		only for 160 A								
 3VM9211-0WD30	Terminal cover for 3-pole breakers	✓	--	--		3VM9111-0WD30		1	1 unit	1CB
		--	✓	--		3VM9211-0WD30		1	1 unit	1CB
		--	--	✓ NEW		3VM9481-0WD30		1	1 unit	1CB
 3VM9211-0WD40	Terminal cover for 4-pole breakers	✓	--	--		3VM9111-0WD40		1	1 unit	1CB
		--	✓	--		3VM9211-0WD40		1	1 unit	1CB
		--	--	✓ NEW		3VM9481-0WD40		1	1 unit	1CB

Connection technology

	Version	For molded case circuit breakers/ frame size			DT	Article No. www.siemens.com/ product?Article.No.	Price per PU	PU (UNIT, SET, M)	PS*/ P. unit	PG			
		3VM 10/11	3VM 12	3VM 13/14									
	Extended terminal cover, for 2-pole breakers including insulating plate	✓	--	--		3VM9111-0WF20	1	1 unit	1CB				
3VM9111-0WF20		only for 160 A											
	Extended terminal cover for 3-pole breakers including insulating plate	✓	--	--		3VM9111-0WF30	1	1 unit	1CB				
3VM9211-0WF30		--	✓	--						3VM9481-0WF30	1	1 unit	1CB
		--	--	✓ NEW									
	Extended terminal cover for 4-pole breakers including insulating plate	✓	--	--		3VM9111-0WF40	1	1 unit	1CB				
3VM9211-0WF40		--	✓	--						3VM9481-0WF40	1	1 unit	1CB
		--	--	✓ NEW									
	Broadened terminal cover for 3-pole breakers including insulating plate	✓	--	--		3VM9111-0WG30	1	1 unit	1CB				
3VM9211-0WG30		--	✓	--						3VM9401-0WG30	1	1 unit	1CB
		--	--	✓ NEW									
	Broadened terminal cover for 4-pole breakers including insulating plate	✓	--	--		3VM9111-0WG40	1	1 unit	1CB				
3VM9211-0WG40		--	✓	--						3VM9401-0WG40	1	1 unit	1CB
		--	--	✓ NEW									
Insulating plates specially for fixed mounted versions													
	Insulating plate, 2-pole	✓	--	--		3VM9111-0WJ20	1	1 unit	1CB				
3VM9111-0WJ20		only for 160 A											
	Insulating plate, 3-pole	✓	--	--		3VM9111-0WJ30	1	1 unit	1CB				
3VM9211-0WJ30		--	✓	--						3VM9481-0WJ30	1	1 unit	1CB
		--	--	✓ NEW									
	Insulating plate, 4-pole	✓	--	--		3VM9111-0WJ40	1	1 unit	1CB				
3VM9211-0WJ40		--	✓	--						3VM9481-0WJ40	1	1 unit	1CB
		--	--	✓ NEW									
	Insulating plate broadened, 3-pole	✓	--	--		3VM9111-0WK30	1	1 unit	1CB				
3VM9211-0WK30		--	✓	--						3VM9481-0WK30	1	1 unit	1CB
		--	--	✓ NEW									

Accessories and Spare Parts

Connection technology

	Version	For molded case circuit breakers/ frame size			DT	Article No. www.siemens.com/ product?Article No.	Price per PU	PU (UNIT, SET, M)	PS*/ P. unit	PG
		3VM 10/11	3VM 12	3VM 13/14						
	Insulating plate broadened, 4-pole	✓	--	--		3VM9111-0WK40		1	1 unit	1CB
		--	✓	--		3VM9211-0WK40		1	1 unit	1CB
		--	--	✓ NEW		3VM9481-0WK40		1	1 unit	1CB
3VM9211-0WK40	DC Insulating plates specially for fixed mounted versions									
	DC insulating plate for 3VM	Versions								
		• For fixed-mounted molded case circuit breakers								
		- 3-pole	✓	--	--		3VM9113-0SG10		1	10 units
	- 4-pole	✓	--	--		3VM9114-0SG10		1	10 units	1CB
3VM9113-0SG10	Side plate specially for fixed mounted versions									
	Side plate for 3VM	Version								
		• For fixed-mounted molded case circuit breakers								
	- 2-pole	✓	--	--		3VM9112-0SG20		1	5 units	1CB
3VM9112-0SG20	Control wire taps for fixed mounted versions									
	Control wire tap for box terminal	✓	--	--		3VM9110-0WB00		1	10 units	1CB
		--	✓	--		3VM9200-0WB00		1	10 units	1CB
		--	--	✓ NEW		3VM9480-0WB00		1	10 units	1CB
3VM9280-0WB00	Control wire tap for busbar	✓	--	--		3VM9110-0WC00		1	10 units	1CB
		--	✓	--		3VM9200-0WC00		1	10 units	1CB
		--	--	✓ NEW		3VM9480-0WC00		1	10 units	1CB
3VM9280-0WC00										

Overview

Using plug-in technology, the 3VM molded case circuit breakers can be installed/removed or replaced quickly and safely. In this case, the cables or busbars of the main current paths are connected to the connectors of the plug-in sockets.

The termination areas of the sockets for these versions are designed in the same way as those of the molded case circuit breakers but, due to the different requirements for creepages and clearances, have slightly different dimensions.

This means the available connection technology is also available for the plug-in socket in the same way.

Connections with insulating measures have their own article numbers and are listed below.

Plug-in technology is a low-cost but also space-saving solution that enables fast replacement of the breaker. The main current paths are connected to the connectors of the plug-in socket. The molded case circuit breaker is equipped with plug-in contacts on the rear. When the circuit breaker is plugged into the socket, the plug-in contacts slide into the socket-side tulip contacts and connect the main current paths with the circuit breaker.



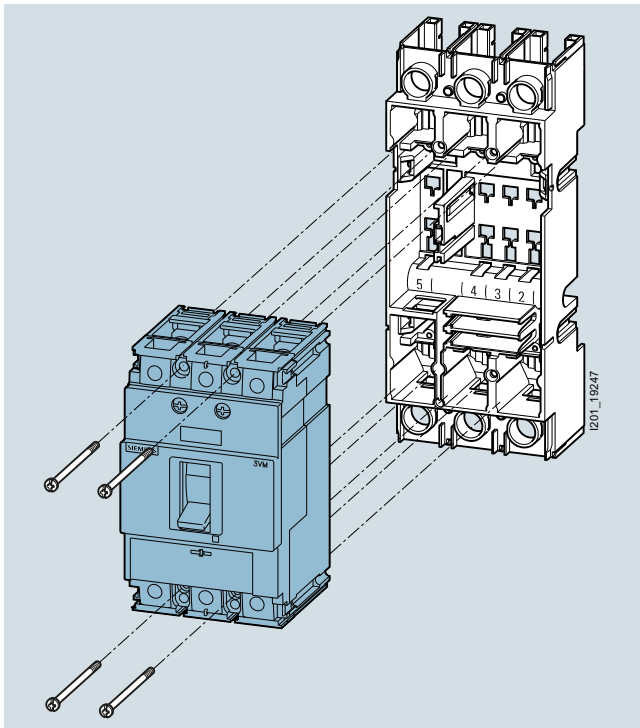

In addition, auxiliary circuit connectors can be used to connect the auxiliary and control signals from the internal accessories of the molded case circuit breaker to the outside. The plug-in unit can be supplied as a complete kit or as a conversion kit for breakers including screw-fastened terminal covers.











Accessories and Spare Parts

Plug-in technology

Selection and ordering data





	Version	For molded case circuit breakers/ frame size			DT	Article No. www.siemens.com/ product?Article No.	Price per PU	PU (UNIT, SET, M)	PS*/ P. unit	PG
		3VM11	3VM12	3VM13/14						
Plug-in socket										
 3VM9113-0KP00  3VM9114-0KP00	Plug-in unit, complete kit									
	Comprising:									
	<ul style="list-style-type: none"> • Plug-in socket • Conversion kit • Mounting screw kit 									
	Versions									
	• 3-pole									
		✓	--	--		3VM9113-0KP00		1	1 unit	1CB
		--	✓	--		3VM9213-0KP00		1	1 unit	1CB
		--	--	✓ NEW		3VM9313-0KP00		1	1 unit	1CB
	• 4-pole									
		✓	--	--		3VM9114-0KP00		1	1 unit	1CB
	--	✓	--		3VM9214-0KP00		1	1 unit	1CB	
	--	--	✓ NEW		3VM9314-0KP00		1	1 unit	1CB	
 3VM9113-0KP10  3VM9114-0KP10	Plug-in unit, conversion kit									
	Comprising:									
	<ul style="list-style-type: none"> • Screw-fastened terminal covers for molded case circuit breakers • Plug-in contacts • Cable cage • Autotrip plunger 									
	Versions									
	• 3-pole									
		✓	--	--		3VM9113-0KP10		1	1 unit	1CB
		--	✓	--		3VM9213-0KP10		1	1 unit	1CB
		--	--	✓ NEW		3VM9313-0KP10		1	1 unit	1CB
	• 4-pole									
		✓	--	--		3VM9114-0KP10		1	1 unit	1CB
	--	✓	--		3VM9214-0KP10		1	1 unit	1CB	
	--	--	✓ NEW		3VM9314-0KP10		1	1 unit	1CB	





Plug-in technology



Version	For molded case circuit breakers/ frame size			DT	Article No. www.siemens.com/ product?Article No.	Price per PU	PU (UNIT, SET, M)	PS*/ P. unit	PG		
	3VM11	3VM12	3VM13/14								
Auxiliary circuit connector											
	Auxiliary circuit connector for all plug-in units							1	1 unit 1CB		
Note: Each auxiliary circuit connector is designed for 4 cables											
3VM9987-0KP80											
Cable cage											
	Cable cage for plug-in unit 3/4-pole (spare part) Cable duct for routing of the required cables from the internal accessories on the back of the circuit breaker							1	1 unit 1CB		
3VM9117-0KB02											
	✓	--	--		3VM9117-0KB02			1	1 unit 1CB		
	--	✓	--		3VM9217-0KB02			1	1 unit 1CB		
	--	--	✓	NEW	3VM9317-0KB02			1	1 unit 1CB		
Spare part: Auto trip plunger NEW											
	Plug-in auto trip plunger Accessory for plug-in unit							1	1 unit 1CB		
3VM9117-0KB81											
	✓	--	--		3VM9117-0KB81			1	1 unit 1CB		
	--	✓	--		3VM9217-0KB81			1	1 unit 1CB		
	--	--	✓		3VM9417-0KB81			1	1 unit 1CB		
Terminal cover specially for plug-in units											
Terminal cover for plug-in unit (spare part) <ul style="list-style-type: none"> To provide circuit breaker touch protection For mounting on the molded case circuit breaker 											
Versions											
	• 3-pole				✓	--	--		3VM9113-0KB01	1	1 unit 1CB
- Included in scope of supply: Cover for infeed and outgoing side											
	--	✓	--		3VM9213-0KB01			1	1 unit 1CB		
	--	--	✓	NEW	3VM9313-0KB01			1	1 unit 1CB		
	• 4-pole				✓	--	--		3VM9114-0KB01	1	1 unit 1CB
- Included in scope of supply: Cover for infeed and outgoing side											
	--	✓	--		3VM9214-0KB01			1	1 unit 1CB		
	--	--	✓	NEW	3VM9314-0KB01			1	1 unit 1CB		
	3VM9114-0KB01										
Terminal cover for plug-in socket <ul style="list-style-type: none"> For touch protection in the termination area of the plug-in socket For mounting on the plug-in socket 											
Versions											
	• 3-pole				✓	--	--		3VM9113-0KB03	1	1 unit 1CB
3VM9113-0KB03											
	--	✓	--		3VM9213-0KB03			1	1 unit 1CB		
	--	--	✓	NEW	3VM9313-0KB03			1	1 unit 1CB		
	• 4-pole				✓	--	--		3VM9114-0KB03	1	1 unit 1CB
3VM9114-0KB03											
	--	✓	--		3VM9214-0KB03			1	1 unit 1CB		
	--	--	✓	NEW	3VM9314-0KB03			1	1 unit 1CB		

Accessories and Spare Parts

Plug-in technology

Version	For molded case circuit breakers/ frame size			DT	Article No. www.siemens.com/ product?Article No.	Price per PU	PU (UNIT, SET, M)	PS*/ P. unit	PG
	3VM11	3VM12	3VM13/14						
Terminal cover extended for plug-in socket <ul style="list-style-type: none"> • For touch protection in the termination area of the plug-in socket • For mounting on the plug-in socket • Included in scope of supply: <ul style="list-style-type: none"> - 1 external terminal cover - 1 insulating plate 									
Versions									
 3VM9113-0KB04	• 3-pole	✓	--	--		3VM9113-0KB04		1	1 unit 1CB
		--	✓	--		3VM9213-0KB04		1	1 unit 1CB
		--	--	✓	NEW	3VM9313-0KB04		1	1 unit 1CB
 3VM9114-0KB04	• 4-pole	✓	--	--		3VM9114-0KB04		1	1 unit 1CB
		--	✓	--		3VM9214-0KB04		1	1 unit 1CB
		--	--	✓	NEW	3VM9314-0KB04		1	1 unit 1CB
Terminal cover broadened for plug-in socket <ul style="list-style-type: none"> • For touch protection in the termination area of the plug-in socket • For mounting on the plug-in socket • Included in scope of supply: <ul style="list-style-type: none"> - 1 external terminal cover - 1 insulating plate 									
Versions									
 3VM9113-0KB05	• 3-pole	✓	--	--		3VM9113-0KB05		1	1 unit 1CB
		--	✓	--		3VM9213-0KB05		1	1 unit 1CB
		--	--	✓	NEW	3VM9313-0KB05		1	1 unit 1CB
 3VM9114-0KB05	• 4-pole	✓	--	--		3VM9114-0KB05		1	1 unit 1CB
		--	✓	--		3VM9214-0KB05		1	1 unit 1CB
		--	--	✓	NEW	3VM9314-0KB05		1	1 unit 1CB

Version	Minimum mm ² for stranded cable	Maximum mm ² for stranded cable	For molded case circuit breakers/ frame size			DT	Article No. www.siemens.com/product?Article No.	Price per PU	PU (UNIT, SET, M)	PS*/P. unit	PG
			3VM11	3VM12	3VM13/14						
Wire connectors specially for plug-in units											
 3VM9153-0JC12	Wire connector, large, with control wire tap Included in scope of supply: 3 single terminals 1 extended terminal cover 1 insulating plate	25 mm ²	150 mm ²	✓	--	--	3VM9153-0JC12		1	1 unit	1CB
		50 mm ²	240 mm ²	--	✓	--					
 3VM9154-0JC12	Wire connector, large, with control wire tap Included in scope of supply: 4 single terminals 1 extended terminal cover 1 insulating plate	25 mm ²	150 mm ²	✓	--	--	3VM9154-0JC12		1	1 unit	1CB
		50 mm ²	240 mm ²	--	✓	--	3VM9254-0JC13		1	1 unit	1CB
 3VM9253-0JC22	Wire connector, 2 cables, with control wire tap Included in scope of supply: 3 single terminals 1 extended terminal cover 1 insulating plate	2 x 25 mm ²	2 x 150 mm ²	--	✓	--	3VM9253-0JC22		1	1 unit	1CB
		2 x 70 mm ²	2 x 300 mm ²	--	--	✓ NEW	3VM9483-0JC23		1	1 unit	1CB
 3VM9254-0JC22	Wire connector, 2 cables, with control wire tap Included in scope of supply: 4 single terminals 1 extended terminal cover 1 insulating plate	2 x 25 mm ²	2 x 150 mm ²	--	✓	--	3VM9254-0JC22		1	1 unit	1CB
		2 x 70 mm ²	2 x 300 mm ²	--	--	✓ NEW	3VM9484-0JC23		1	1 unit	1CB

Version	For molded case circuit breakers/ frame size	DT			Article No. www.siemens.com/product?Article No.	Price per PU	PU (UNIT, SET, M)	PS*/P. unit	PG
		3VM11	3VM12	3VM13/14					
Control wire taps specially for plug-in units									
 3VM9280-0WB00	Control wire tap for box terminal	✓	--	--	3VM9150-0WB00		1	10 units	1CB
		--	✓	--	3VM9280-0WB00		1	10 units	1CB
		--	--	✓ NEW	3VM9480-0WB00		1	10 units	1CB
 3VM9280-0WC00	Control wire tap for busbar	✓	--	--	3VM9150-0WC00		1	10 units	1CB
		--	✓	--	3VM9280-0WC00		1	10 units	1CB
		--	--	✓ NEW	3VM9480-0WC00		1	10 units	1CB

Accessories and Spare Parts

Residual current devices

Overview

Residual current devices can be used to prevent or reduce hazardous residual currents that could cause injury to personnel and livestock, and damage to property. These are available as accessory components for the 3VM series up to the largest circuit breaker size. All residual current devices detect both purely sinusoidal AC residual currents as well as pulsating DC residual currents (type A), and the combination of molded case circuit breakers or switch disconnectors with mounted residual current devices complies with IEC 60947-2 Annex B.

The residual current devices are characterized by the following features:

- Compact design
- 45 mm cover size
- LEDs for signaling "ready" state and pre-alarms
- Tripped signal at device and via electrical contacts
- Deliberate acknowledgment following a trip via a reset push-button on the residual current device

The RCD110 and RCD210 units are specially designed for the infrastructure market. This is reflected in the design: they have a compact L-shaped design, the operator controls and displays are in a 45 mm cover size, DIN rail mounting is possible, and the combination of breaker and residual current device has a depth of 70 mm and thus fits optimally into a distribution board.



The residual current devices are mounted on the left side of the breaker. Through-hole technology enables direct connection of the cable to the box terminal. There is no need for time-consuming wiring of the breaker-residual current device combination. In the event of a residual current, the breaker is tripped by an RCR (residual current release) built into the left accessories compartment of the breaker and is included in the scope of delivery. However, this RCR can also be used by means of a floating contact as a shunt trip independently of the residual current device.

On the residual current devices of the 2-series (RCD210) tripping can be delayed by up to three seconds so that in the event of a fault, only the branch containing the fault is switched off by means of appropriate selective grading of the series-switched residual current devices. The RCD110 is an instantaneous version, in other words, it trips immediately. Both versions can be supplied as 4-pole versions.



RCD210

Selection and ordering data

Version	For molded case circuit breakers/ frame size	DT	Article No. www.siemens.com/ product?Article No.	Price per PU	PU (UNIT, SET, M)	PS*/ P. unit	PG
	3VM11 3VM12						
Side mounted residual current devices RCD for 3VM							
<p>Type A (pulse current sensitive)</p> <ul style="list-style-type: none"> Mounted on the side (left) Trip element (RCR) included in the scope of delivery Can be mounted on molded case circuit breakers and switch disconnectors $U_e = 127 - 480 \text{ V AC}, 50/60 \text{ Hz}$ <p>Note NEW</p> <ul style="list-style-type: none"> 1 set of box terminals (4 pieces) is included in the delivery package of the RCD110 or RCD210 							
 3VM9114-0RS10	<p>RCD110</p> <ul style="list-style-type: none"> 4-pole Rated residual response current, adjustable: $I_{\Delta n} = 0.03 - 0.05 - 0.1 - 0.3 - 0.5 - 1 - 3 - 5 \text{ A}$; default: 30 mA Delay time, permanently set: $\Delta t = \text{instantaneous (INS)}$ 	✓	--		3VM9114-0RS10	1	1 unit 1CB
	<p>RCD210</p> <ul style="list-style-type: none"> 4-pole Rated residual response current, adjustable: $I_{\Delta n} = 0.03 - 0.05 - 0.1 - 0.3 - 0.5 - 1 - 3 - 5 \text{ A}$; default: 30 mA Delay time, adjustable: $\Delta t = \text{instantaneous (INS)} - 0.06 - 0.15 - 0.3 - 0.5 - 1 - 2 - 3 \text{ s}$; default: instantaneous (INS) 	✓	--		3VM9114-0RS20	1	1 unit 1CB
 3VM9114-0RS20		--	✓		3VM9214-0RS20	1	1 unit 1CB
	Spare part: Residual Current Release NEW						
 3VM9988-0BR10	<p>Residual Current Release (RCR)</p> <ul style="list-style-type: none"> Accessory for side mounted RCD110 and RCD210 Scope of delivery: RCR, RCR-RCD cable 				3VM9988-0BR10	1	1 unit 1CB
	<p>Note</p> <ul style="list-style-type: none"> for all side mounted residual current devices 						

Accessories and Spare Parts

Locking technology

Overview

The padlock devices make it possible to lock the 3VM molded case circuit breaker in either the OFF or the ON operating position. Once the molded case circuit breaker is locked in position, it cannot be operated again.

Locking technology

Padlock device for the handle

A padlock device mounted and latched on the handle allows the 3VM molded case circuit breaker to be locked in the ON or the OFF position.

In this position, up to 3 padlocks with diameters ranging from 4.5 mm to 8.5 mm can be fitted in order to prevent the handle from being moved.

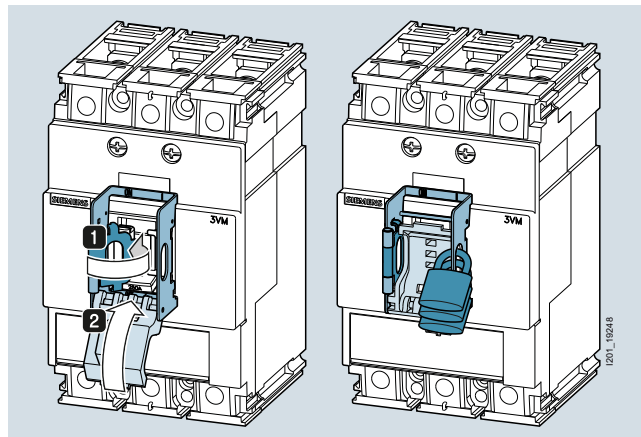





3

Selection and ordering data

Version	For molded case circuit breakers/ frame size			DT	Article No. www.siemens.com/ product?Article No.	Price per PU	PU (UNIT, SET, M)	PS*/ P. unit	PG
	3VM10/11	3VM12	3VM13/14						
Accessories for locking									
 3VM9188-0LB10	Locking devices for handles								
	✓	✓	--		3VM9188-0LB10		1	1 unit	1CB
	--	--	✓ NEW		3VM9388-0LB10		1	1 unit	1CB

Selection and ordering data

Version	For molded case circuit breakers/ frame size				DT	Article No. www.siemens.com/ product?Article No.	Price per PU	PU (UNIT, SET, M)	PS*/ P. unit	PG
	3VM	10	11	12	13/14					
Adapter for DIN rails for 3VM molded case circuit breakers										
 Adapter for DIN rails for 3VM molded case circuit breakers										
Versions										
• 1-pole ¹⁾	--	✓	--	--		3VM9181-0SH10		1	1 unit	1CB
• 2-pole	--	✓	--	--		3VM9182-0SH10		1	1 unit	1CB
• 3 and 4-pole	✓	✓	--	--		3VM9187-0SH10		1	1 unit	1CB
• 4-pole in conjunction with RCD110 or RCD210	--	✓	--	--		3VM9187-0SH20		1	1 unit	1CB
Adapter for 60 mm busbar system (8US)										
 Adapter for 60mm busbar system (8US)										
Versions										
• 3-pole	✓	✓	--	--		8US1213-4AU01		1	1 unit	1CU
	--	--	✓	--		8US1213-4AP03		1	1 unit	1CU
Mounting screw kit										
 Mounting screw kit										
Versions										
• For fixed-mounted molded case circuit breakers										
- 1-pole	--	✓	--	--		3VM9111-0SS10		1	1 unit	1CB
- 2 and 3-pole (apart from 125 A/160 A with 55 kA)	✓	✓	✓	--		3VM9116-0SS10		1	1 unit	1CB
- 3-pole (125 A/160 A with 55 kA) and 4-pole	✓	✓	✓	--		3VM9114-0SS10		1	1 unit	1CB
	--	--	--	✓	NEW	3VM9317-0SS10				
• For plug-in technology	--	✓	✓	--		3VM9114-0SS10		1	1 unit	1CB
	--	--	--	✓	NEW	3VM9317-0SS10		1	1 unit	1CB
Transparent TMTU cover, sealable										
 Transparent TMTU cover For covering and sealing the trip unit for the TM120M and TM220 ATFM trip unit types										
Versions										
• 3 and 4-pole	--	✓	--	--		3VM9157-0SA10		1	5 units	1CB
	--	--	✓	--		3VM9257-0SA10		1	5 units	1CB
	--	--	--	✓	NEW	3VM9457-0SA10		1	5 units	1CB

¹⁾ For 3VM molded case circuit breakers, 160 A 1-pole up to 25 kA

Accessories and Spare Parts

Notes

Appendix



4/2	Catalog notes
4/3	Ordering notes
4/5	Further documentation
4/9	Quality management
4/10	Standards and approvals
4/12	Siemens contacts
4/13	Service & Support
4/14	Comprehensive support from A to Z
4/15	Article No. index incl. export markings
4/16	Conditions of sale and delivery

Appendix

Catalog notes

Overview

Trademarks

All product designations may be registered trademarks or product names of Siemens AG or supplier companies whose use by third parties for their own purposes may violate the rights of the owner.

Amendments

Unless stated otherwise on the individual pages of this catalog, we reserve the right to make changes, in particular to the specified values, measurements and weights.

Dimensions

All dimensions are given in mm.

Illustrations

The illustrations are not binding.

Technical specifications

The technical specifications are for general information purposes only. Always heed the operating instructions and notices on individual products during assembly, operation and maintenance.

Further technical information is available at www.siemens.com/lowvoltage/product-support

- under "Entry type":
 - Application example
 - Certificate
 - Characteristic
 - Download
 - FAQ
 - Manual
 - Product note
 - Software archive
 - Technical data



Configurators can be found at www.siemens.com/lowvoltage/configurators

Assembly, operation and maintenance

Always heed the operating instructions and notices on individual products during assembly, operation and maintenance.

Symbols

In the table below, you will find all symbols concerning connections that can occur in this catalog. In combination with orange highlighting, these identify special selection criteria.

Connections	
	Screw connection
	Ring cable lug connection
	Spring-loaded terminals

Logistics

General

With regard to delivery service, communications and environmental protection, our logistics service ensures "quality from the moment of ordering right through to delivery". By designing our infrastructure according to customer requirements and implementing electronic order processing, we have successfully optimized our logistics processes.

We are proud of our personal consulting service, on-time deliveries and one-day transport within Germany.

To this end, we supply preferred types marked with ► ex works.

We regard the ISO 9001 certification and consistent quality checks as an integral part of our services.

Electronic order processing is fast, cost-efficient and error-free. Please contact us if you want to benefit from these advantages.

Packaging, packing units

The packaging in which our equipment is dispatched provides protection against dust and mechanical damage during transport, thus ensuring that all our products arrive in perfect condition.

We select our packaging for maximum environmental compatibility and reusability (e.g. crumpled paper for protection during transport in packages up to 32 kg) and, in particular, with a view to reducing waste.

With our multi-unit and reusable packaging, we offer you specific types of packaging that are both kind to the environment and tailored to your requirements:

Your advantages at a glance:

- Lower ordering costs.
- Cost savings through same-material type packaging: Low/no disposal costs.
- Reduced time and cost thanks to short unpacking times.
- "Just-in-time" delivery directly to the production line helps reduce stock: Cost savings through reduction of storage areas.
- Fast assembly thanks to supply in sets.
- Standard Euro boxes - corresponding to the Euro pallet modular system - suitable for most conveyor systems.
- Active contribution to environmental protection.

Unless stated otherwise in the "Selection and ordering data" of this catalog, our products are supplied individually packed.

For small parts/accessories, we offer you cost-effective packaging units as standard packs containing more than one item, e.g. 5, 10, 50 or 100 units. It is essential that whole number multiples of these quantities be ordered to ensure satisfactory quality of the products and problem-free order processing.

The products are delivered in a neutral carton. The label includes warning notices, the CE marking, and device descriptions in English and German.

In addition to the Article No. (MLFB) and the number of items in the packaging, the operating instructions article number (Instr.-Order-No.) is also specified. It can be obtained from your local Siemens representative (for a list of your Siemens contacts, see www.siemens.com/lowvoltage/contact).

Most device Article No.'s can be obtained by means of the EAN barcode to simplify ordering and storage logistics.

The associated master data, too, is available from your local Siemens representative.

Appendix

Ordering notes

Overview

Ordering special versions

When ordering products that differ from the standard versions listed in the catalog, "-Z" must be added to the Article No. indicated and the required features must be specified using alphanumeric order codes or plain text.

Ordering very small quantities

When very small orders are placed, the costs associated with order processing are greater than the order value. We therefore recommend that you combine several small orders. Where this is not possible, we regret that we are obliged to make a small processing charge: for orders with a net goods value of less than € 250 we charge an € 20 supplement to cover our order processing and invoicing costs.

Explanations of Selection and Ordering Data

X On request In such cases, the delivery time can be queried.

Price units (PU)

The price unit defines the number of units, sets or meters to which the specified price applies.

Packaging size (PS)

The packaging size defines the number of units, sets or meters, for example, for outer packaging. Only the quantity defined by the packaging size or a multiple thereof can be ordered.

Price group (PG)

Each product is allocated to a price group.

Example

5TT3400

SD: Preferred type

PG: 1BK

Ordering quantity 1 unit or a multiple thereof

8US1923-5CA02

PG: 1CU

Ordering quantity 10 units or a multiple thereof

8WH9000-1GA00

PG: 1BT

Ordering quantity 50 units or a multiple thereof

SD	Article No.	Price per PU	PU (UNIT, SET, M)	PS*	PG
d	5TT3400		1	1 unit	1BK
	8US1923-5CA02		1	10 units	1CU
	8WH9000-1GA00		100	50 units	1BT

Note:

The article numbers shown here and the specifications regarding selection and ordering data are examples only. When ordering, always use the selection and ordering data in the product chapters.

Metal surcharges/export markings

To compensate fluctuating prices of raw materials (for example silver, copper, aluminum, lead, gold, dysprosium and neodymium), surcharges are calculated on a daily basis for products containing these raw materials using the metal factor. A surcharge for the particular raw material is added to the price of a product if the basic quotations for this raw material are exceeded.

Each product's metal factor dictates for which raw materials the metal surcharges are calculated, from which quotation and with which calculation method (weight or percentage method).

An exact explanation of the metal factor can be found at www.siemens.com/automation/salesmaterial-as/catalog/en/terms_of_trade_en.pdf

A product's export markings/metal surcharges are updated daily at www.siemens.com/industrymall.

Low-Voltage Power Distribution and Electrical Installation Technology on the WWW

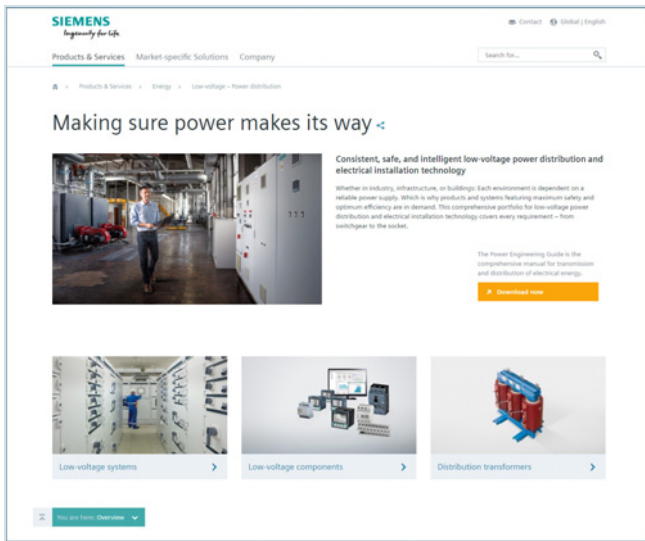

On the Internet you will find a host of information all about low-voltage power distribution and electrical installation technology products, such as:

- Overview of our product portfolio
- Background information, news and dates
- Videos, podcasts and newsletters
- Links to blogs and Twitter
- Brochures, catalogs, operating instructions and manuals for direct download

Visit us online and get to know our product range!

www.siemens.com/lowvoltage

Product selection using the interactive catalog CA 01

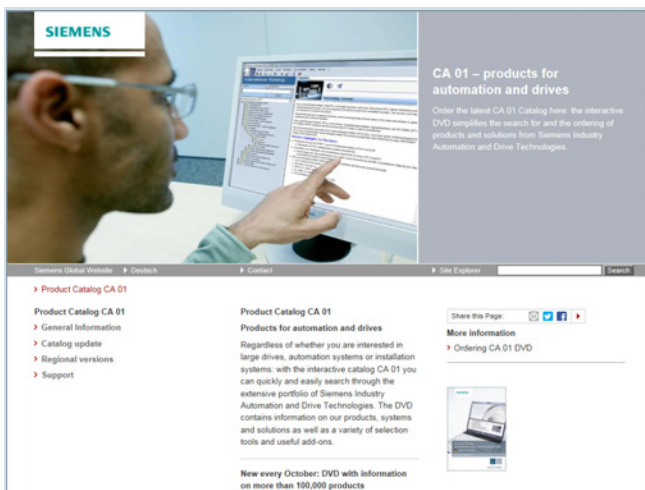

Detailed information together with user-friendly interactive functions

The interactive catalog CA 01 covers more than 100 000 products, thus providing a comprehensive overview of the product range provided by Siemens.

You can find everything you need here for solving automation, switching, installation and drive technology tasks. All information is provided over a user interface that is both user-friendly and intuitive.

Information about the interactive catalog CA 01 can be found on the Internet at:

www.siemens.com/automation/ca01

or on DVD.

Industry Mall

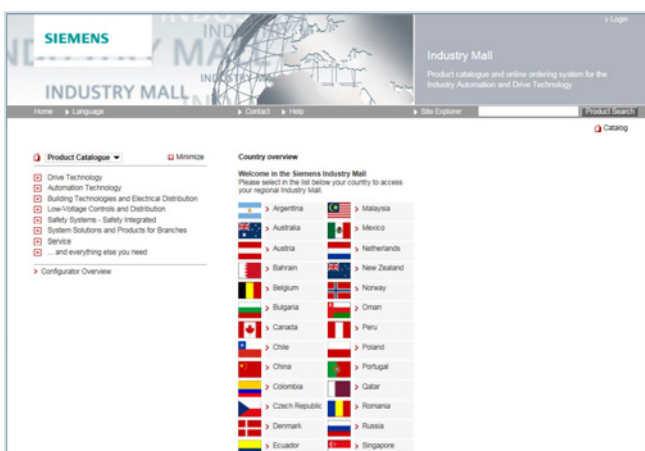

The Industry Mall – for online information, product selection and ordering

- Detailed information including product data, illustrations, certificates and CAX data
- Simple configuring of systems
- Possible to request individualized quotations
- Availability check
- Online ordering facility
- Order tracking/order overview
- Fast access to relevant training offers and services

You can find the Industry Mall on the Internet at

www.siemens.com/industrymall

Appendix

Further documentation

Industry Online Support



Comprehensive support – at any time, whatever your location

- FAQs, sample applications, information about successor products and product news
- Prompt assistance with technical queries
- Discussions and best practice sharing with other users in the forum
- Provision of high-quality product data for your planning programs
- Faster access to information – with helpful filter and folder functions in mySupport
- Automatic notification service to keep you up to date with the latest information about topics of interest to you

You can find Siemens Industry Online Support on the Internet at: www.siemens.com/online-support

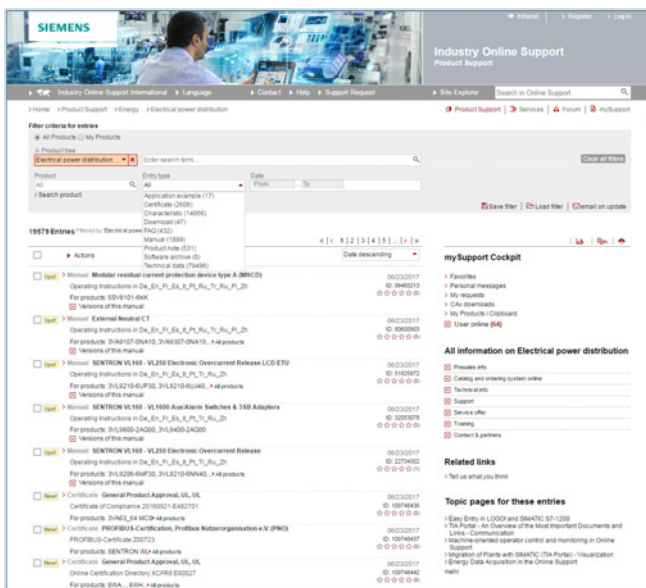

In the "Entry type" selection box in Product Support, you will find the following:

- Application example
- Certificate
- Characteristic
- Download
- FAQ
- Manual
- Product note
- Software archive
- Technical data

www.siemens.com/lowvoltage/product-support

In addition, the Low-Voltage Power Distribution and Electrical Installation Technology catalogs are also available there.

www.siemens.com/lowvoltage/catalogs

Industry Online Support App



Main functions at a glance

- Scanning of product codes (EAN/QR and data matrix codes) with direct display of all technical information on the product, including graphic data (CAx data).
- Delivery of product information or entries by email, so that the information can immediately be processed at the workplace.
- Submission of queries to Technical Support (Support Requests). With photo function for transmitting detailed information.
- Contents and interfaces available in 6 languages (German, English, French, Italian, Spanish and Chinese) – including option of temporary switchover to English.
- Offline cache function for all favorites stored in "mySupport". These entries can also be retrieved without network reception.
- Import of PDF documents into a library (e.g. iBooks or similar).

You can find information on the Industry Online Support App on the Internet at

www.siemens.com/industry/onlinesupportapp



Android:

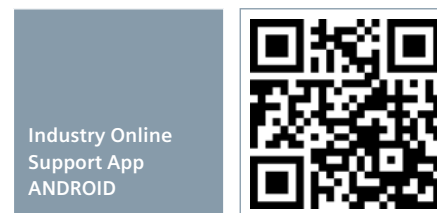

Apple iOS:



Windows:



Appendix

Further documentation

Product configurator

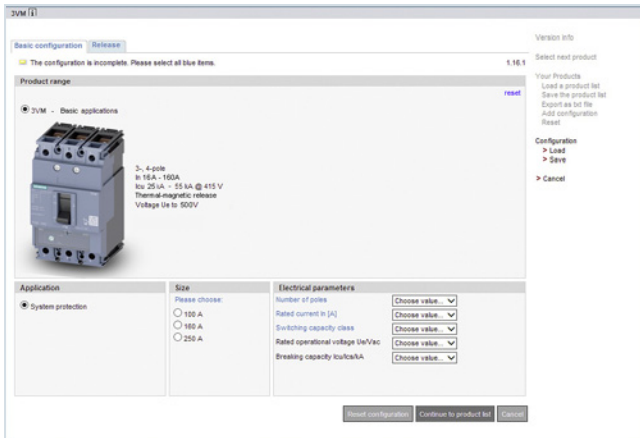

Finding the right product faster

- Complete selection of products and systems based on technical characteristics or application requirements
- Simple, intuitive operation
- Option to save the configuration and order lists in a file format of your choice (txt, pdf, xls, csv)
- Direct transfer of the order list into the shopping cart of the Siemens Industry Mall
- Fast access to product data, diagrams, certificates and CAx data for the selected product and system configuration
- Available in multiple languages for use by customers anywhere in the world

The configurators are available online in the Siemens Industry Mall and offline in Catalog CA 01.

You can find our configurators at the following website:

www.siemens.com/lowvoltage/configurators

CAx Download Manager

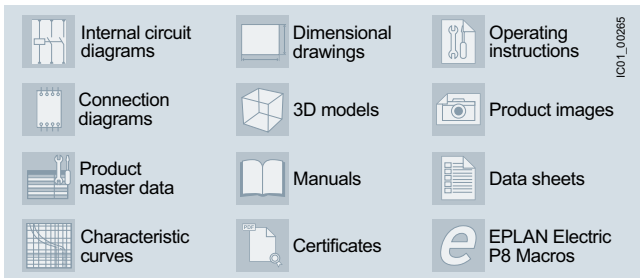

Time savings of up to 80% with universal product data for your CAE and CAD systems

The CAx Download Manager can supply you with all the necessary CAx file types for the products of your choice for use in all common CAE and CAD systems. The data contained in the files is continuously updated. The whole process involves only four selection steps and is free of charge. All your selected files are packed into a zip file which you can download for further use.

Siemens makes available up to 12 file types to support your mechanical (CAD) and electrical (CAE) planning processes for you to download at any time of the day.

- No manual data collection necessary
- Universal manufacturer data for all common CAE and CAD systems
- Standardized documentation is simple to generate
- Choice of different languages for system commissioning anywhere in the world

You can find the CAx Download Manager on the Internet at

www.siemens.com/lowvoltage/cax

My Documentation Manager

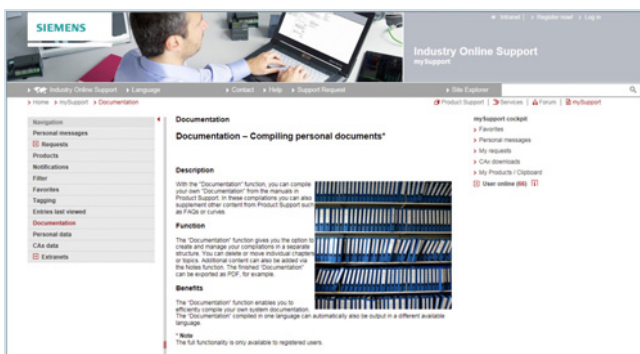

User-friendly compilation of project-specific documentation

In accordance with directives*, the documentation is part of the plant and requires certification, thus giving the purchaser the right to full plant documentation.

To support you in this, a manual configurator has been developed with which you can put together individual and standard-compliant documentation – fully in accordance with the relevant project-specific requirements.

You can thus select the chapters relevant to the respective project from the available manuals of the installed Siemens components. FAQs, certificates, data sheets and your own content can also be incorporated.

- Compile and structure manuals, data sheets, FAQs and certificates simply by dragging and dropping
- Insert personalized content via the Notes function
- Further processing possible thanks to selectable export formats (pdf, xml, rtf)
- After generating the documentation, automatic translation into the desired language is possible
- Always up-to-the minute thanks to the Update function

In "mySupport" you can compile individual documentation for your project by dragging and dropping

* e.g. Low Voltage Directive 2006/95/EC and EC Machinery Directive 2006/42/EC

You can find My Documentation Manager on the Internet at

www.siemens.com/lowvoltage/mdm

Overview

The quality management system of our "Low Voltage & Products" Business Unit in the "Energy Management" Division complies with the international EN ISO 9001 standard.

The products and systems listed in this catalog are developed and manufactured using a certified quality management system in accordance with EN ISO 9001:2008.

Appendix

Standards and approvals

Overview

Certificates

An overview, updated on a daily basis, of our products certified in accordance with CE, UL, CSA, FM, shipping authorizations etc. for low-voltage power distribution and electrical installation products can be found on the Internet at

www.siemens.com/lowvoltage/certificates

The screenshot shows the Siemens Industry Online Support interface. The top navigation bar includes 'Intranet', 'Register', and 'Log in'. The main header is 'Industry Online Support Product Support'. Below this is a breadcrumb trail: 'Home > Product Support > Energy > Electrical Distribution'. The 'Filter criteria for entries' section is active, showing 'All Products' selected, 'Product tree' set to 'Electrical Distribution (3964)', 'Entry type' set to 'Certificate (3964)', and 'Date' set to 'From' to 'To'. Other filters include 'Certificate type' (All), 'Approval office' (All), and 'Country' (All). The main content area displays '3964 Entries' with a table of results. The table has columns for 'Actions', 'Certificate details', 'Date', and 'Rating'. The first few entries are:

Actions	Certificate	Date	Rating
<input type="checkbox"/>	UBC, CBC, IBC Certificate of Seismic Compliance 137-1000, 137-1001, 137-1002 For products: SIVACON SICUBE 8MF1 ▶ All products	06/03/2016 ID: 109738005	☆☆☆☆ (0)
<input type="checkbox"/>	IEC 60980, IEC 60068-2-57 Certificate of Seismic Compliance 137-1000, 137-1001, 137-1002 For products: SIVACON SICUBE 8MF1 ▶ All products	06/03/2016 ID: 109738004	☆☆☆☆ (0)
<input type="checkbox"/>	General Product Approval, TSE, TSE TSE-Certificate 000082-TSE-02/01 For products: 5SL3..., 5SL6..., 5SL3...-YA, 5SL6...-YA ▶ All products	06/03/2016 ID: 109738035	☆☆☆☆ (0)
<input type="checkbox"/>	General Product Approval, TSE, TSE TSE Certificate 104688-TSE-01/01 For products: 5SL3..., 5SL6..., 5SL3...-YA, 5SL6...-YA ▶ All products	06/03/2016 ID: 109738036	☆☆☆☆ (0)
<input type="checkbox"/>	Declaration of Conformity, EC/EU-Declaration of Conformity, Manufacturer EU Declaration of Conformity 16047414.v01	06/02/2016 ID: 109738003	

On the right side, there is a 'mySupport Cockpit' with links for 'Favorites', 'Personal messages', 'My requests', 'CAx downloads', 'My Products / Clipboard', and 'User online (78)'. Below that is 'All information on Electrical Distribution' with links for 'Presales info', 'Catalog and ordering system online', 'Technical info', 'Support', and 'Service offer'.

In the **Entry list**, you can **filter the view** in order to quickly find comprehensive information on the following subjects:

- Product or search term
- Date
- Type of certificate (general product approval, test certificates, shipping approval, ...)
- Certificate (confirmations, UL, VDE, ...)
- Approval office (TÜV, VDE, UL, ...)
- Country

This screenshot shows the same website interface but with more filters applied. The 'Product tree' is now 'Electrical Distribution (323)', 'Entry type' is 'Certificate (323)', and 'Approval office' is 'VDE (323)'. The main content area displays '323 Entries' with a table of results. The table has columns for 'Actions', 'Certificate details', 'Date', and 'Rating'. The first few entries are:

Actions	Certificate	Date	Rating
<input type="checkbox"/>	General Product Approval, VDE, VDE VDE Marks Approval 40038886 For products: 5TL1 ▶ All products		
<input type="checkbox"/>	General Product Approval, VDE, VDE VDE Marks Approval 40029763 For products: 5SH112 ▶ All products		
<input type="checkbox"/>	General Product Approval, VDE, VDE VDE Marks Approval 40029762 For products: 5SH113 ▶ All products		
<input type="checkbox"/>	General Product Approval, VDE, VDE VDE Marks Approval 40029716 For products: 5SH1231 ▶ All products		
<input type="checkbox"/>	General Product Approval, VDE, VDE VDE Marks Approval 40029715 For products: 5SH1221 ▶ All products		

On the right side, there is a 'mySupport Cockpit' with links for 'Favorites', 'Personal messages', 'My requests', 'CAx downloads', 'My Products / Clipboard', and 'User online (78)'. Below that is 'All information on Electrical Distribution' with links for 'Presales info', 'Catalog and ordering system online', 'Technical info', 'Support', and 'Service offer'.

Approval requirements valid in different countries

Siemens low-voltage switchgear and controlgear are designed, manufactured and tested according to the relevant German standards (DIN and VDE), IEC publications and European standards (EN) as well as CSA and UL standards. You will find the standards assigned to the single devices in the relevant certificates at

www.siemens.com/lowvoltage/certificates

In addition to the pertinent VDE, EN and IEC standards, the requirements of the various regulations valid in other countries have also been taken into account in the design of the equipment in some cases, in order that the devices can be deployed globally as far as possible.

In some countries an approval is required for certain low-voltage switchgear and controlgear components. Depending on the market requirements, these devices have been submitted for approval to the authorized testing institutes.

In some cases, CSA for Canada and UL for the USA only approve special versions. Such special versions are listed separately from the standard versions in the relevant parts of this catalog.

For this equipment, there are sometimes limits with regard to the maximum permissible voltages, currents and rated outputs or special approvals and, in some cases, special identification may be required.

For use on board ship, the specifications of the marine classification societies must be observed. In some cases, they require type tests of the components to be approved.

For more information on UL, visit

www.siemens.com/applicationconsulting/ul

If you have any questions concerning UL/CSA approvals, please contact Technical Support:

www.siemens.com/lowvoltage/contact

Appendix

Siemens contacts

Contacts for low-voltage power distribution and electrical installation technology

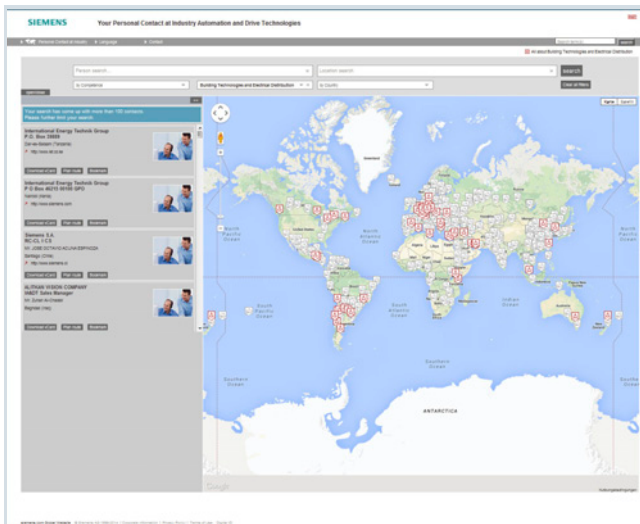

With low-voltage power distribution and electrical installation technology we consistently pursue one goal:

long-term improvement of your competitive ability.

We are committed to this goal. Thanks to our dedication, we are continually setting new standards. In all industries – worldwide.

At your service, locally, around the globe: Partners for consulting, sales, training, service, support, spare parts ... on the entire range of low-voltage power distribution and electrical installation technology.

Your personal contact can be found in our Contact Database at www.siemens.com/lowvoltage/contact

You start by selecting a

- Required competence
- Product or sector
- Country
- City

or by performing a

- search for a specific location or
- individual.

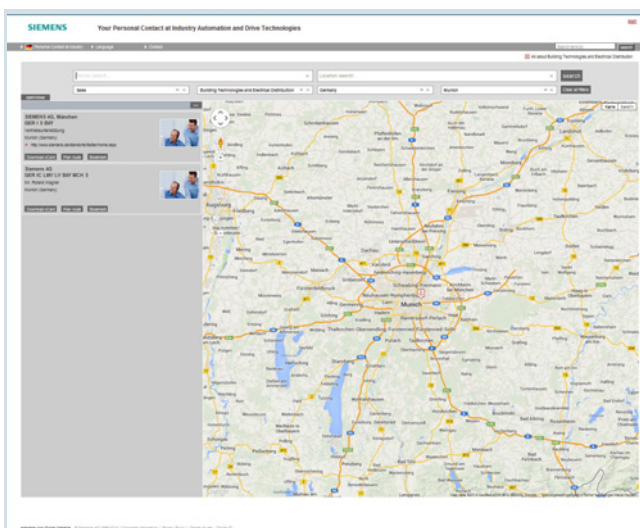

Unrivalled complete range of services over the entire life cycle

Online Support



Our comprehensive online information platform covers every aspect of our Service & Support and is available whenever, wherever.

You will find further information at
www.siemens.com/online-support
www.siemens.com/lowvoltage/product-support

Field Service



Siemens Field Service offers support with all aspects of maintenance – so that the availability of your machines and plants is assured whatever the case.

You will find further information at
www.siemens.com/com/lowvoltage/contact

Technical Support



The competent consulting service for technical issues with a broad range of customer-oriented services for all our products and systems.

Assistance with technical queries is provided at
www.siemens.com/lowvoltage/support-request
 You can find your local contacts at
www.siemens.com/lowvoltage/contact

Spare Parts



Plants and systems in all industries worldwide are expected to meet ever higher levels of availability. We can help you rule out unexpected stoppages: with a global network and optimum logistics chains.

You will find further information at
www.siemens.com/lowvoltage/contact

Training



Extend your lead – with practice-related know-how straight from the manufacturer.

You will find further information at
www.siemens.com/lowvoltage/training

Specification texts

You can obtain qualified, free support to help you produce specifications for technically equipping non-residential and industrial buildings at
www.siemens.com/specifications

Appendix

Comprehensive support from A to Z

Overview

Product information	
Website	Fast and targeted information on low-voltage power distribution and electrical installation technology: www.siemens.com/lowvoltage
Newsletter	Always up to date about our trend-setting products and systems: www.siemens.com/lowvoltage/newsletter
Product information/product & system selection	
Siemens Industry Online Support	Low-Voltage Power Distribution and Electrical Installation Technology catalogs www.siemens.com/lowvoltage/catalogs
Industry Mall	Comprehensive information and order platform for the Siemens Industry Basket: www.siemens.com/lowvoltage/mall
CA 01	Every product for automation and drive technology, Interactive Catalog, DVD
Product and system engineering	
SIMARIS planning tools	Support in planning and configuring the electrical power distribution: www.siemens.com/simaris
SIMARIS configuration configuration software	Support throughout the entire configuration cycle from the configuration of SIVACON S8 switchboards, ALPHA distribution boards, cost calculations and quotation preparation, right through to the creation of plant documentation: www.siemens.com/simarisconfig
Software for power loss calculations - SIMARIS therm	Support in performing power loss calculations for the dimensioning of control cabinets: www.siemens.com/simaristherm
Product documentation	
Siemens Industry Online Support	Comprehensive technical information – from planning to configuration and operation: www.siemens.com/online-support www.siemens.com/lowvoltage/product-support
Product configurator	Complete selection of products and systems based on technical characteristics or application requirements: www.siemens.com/lowvoltage/configurators
CAX Download Manager	Collation of CAX data types for standard CAE and CAD systems: www.siemens.com/lowvoltage/cax
My Documentation Manager	Compilation of project-specific documentation: www.siemens.com/lowvoltage/mdm
Image database	Collection of product photographs and graphics, such as dimensional drawings and internal circuit diagrams: www.siemens.com/lowvoltage/picturedb
Product training	
SITRAIN Portal	Comprehensive training program for our products, systems and engineering tools: www.siemens.com/lowvoltage/training
Product hotline	
Technical Support	Support in all technical queries about our products: www.siemens.com/lowvoltage/contact www.siemens.com/lowvoltage/support-request

Appendix

Conditions of sale and delivery

1. General standards

By using this catalog you can acquire hardware and software products described therein from Siemens AG subject to these conditions of sale and delivery (hereinafter: CSD). Please note: the scope, the quality and the conditions for supplies and services, including software products, by any Siemens group or Regional Company having a registered office outside of Germany, shall be subject exclusively to the General Terms and Conditions of the respective Siemens entity. These CSD apply exclusively for orders placed with Siemens AG, Germany.

1.1 For customers with a seat or registered office in Germany

For customers with a seat or registered office in Germany, the following shall be subordinate to these CSD

- the "General Terms of Payment"¹⁾ and
- for software products, the "General License Conditions for Software Products for Automation and Drives for Customers with a Seat or Registered Office in Germany"¹⁾ and
- the "General Conditions for the Supply of Products and Services of the Electrical and Electronics Industry"¹⁾ for other deliveries and services.

1.2 For customers with a seat or registered office outside of Germany

For customers with a seat or registered office outside of Germany, the following shall be subordinate to these CSD

- the "General Terms of Payment"¹⁾ and
- for software products, the "General License Conditions for Software Products for Automation and Drives for Customers with a Seat or Registered Office outside of Germany"¹⁾ and
- the "General Conditions for Supplies of Siemens Industry for Customers with a Seat or Registered Office outside of Germany"¹⁾ for other deliveries and services.

2. Prices

The prices are in € (Euro) ex works, excluding packaging.

The sales tax (value added tax) is not included in the prices. It shall be debited separately at the respective rate according to the applicable legal regulations.

Prices are subject to change without prior notice. We will debit the prices valid at the time of delivery.

To compensate fluctuating prices of raw materials (for example silver, copper, aluminum, lead, gold, dysprosium and neodymium), surcharges are calculated on a daily basis for products containing these raw materials using the metal factor. A surcharge for the particular raw material is added to the price of a product if the basic quotations for this raw material are exceeded.

Each product's metal factor dictates for which raw materials the metal surcharges are calculated, from which quotation and with which calculation method (weight or percentage method).

An exact explanation of the metal factor can be found at www.siemens.com/automation/salesmaterial-as/catalog/en/terms_of_trade_en.pdf

The surcharge will be calculated (except in the case of dysprosium and neodymium) on the basis of the official price on the day prior to receipt of the order or prior to the release order for calculation of the surcharge.

In the event of placement of an order, the relevant three-month average price from the quarter prior to order receipt or the release order shall be used with a one-month buffer to calculate the dysprosium and neodymium surcharge ("rare earths") (you will find details in the aforementioned explanation of the metal factor).

3. Additional terms and conditions

All dimensions are in mm. In Germany, according to the German law on units in metrology, data in inches only apply to devices for export.

Illustrations are not binding.

Insofar as there are no remarks on the corresponding pages of this catalog - especially with regard to data, dimensions and weights given - these are subject to change without prior notice.

4. Export regulations

We shall not be obligated to fulfill this agreement if such fulfillment is prevented by any impediments arising out of national or international foreign trade or customs requirements or any embargoes or other sanctions.

Export of the products listed in this catalog may be subject to authorization. In delivery information, we label authorization obligations according to German, European and US export lists. Goods labeled with an "AL" not equal to "N" are subject to European or German export authorization when being exported out of the EU. Goods labeled with "ECCN" not equal to "N" are subject to a US re-export authorization.

Please note that you can also preview the export designations in the respective product description via our "Industry Mall" online catalog system. The deciding factors, however, are the AL or ECCN export designations indicated on order confirmations, delivery notes and invoices.

Even if goods are not labeled, or labeled "AL:N" or "ECCN:N", they may still be subject to export authorization based on the final destination and end use of the goods.

If you transfer goods (hardware and/or software and/or technology as well as corresponding documentation, regardless of the mode of provision) delivered by us or works and services (including all kinds of technical support) performed by us to a third party worldwide, you shall comply with all applicable national and international (re-) export control regulations.

If required to conduct export control checks, you, at our request, shall promptly provide us with all information pertaining to particular end customers, destination and intended use of goods, works and services provided by us, as well as any relevant export control restrictions.

The products listed in this catalog may be subject to European/German and/or US export regulations. Therefore, any export requiring a license is subject to approval by the competent authorities.

Errors excepted and subject to change without prior notice.

¹⁾ You can download the text of the Siemens AG terms and conditions of trade at

www.siemens.com/automation/salesmaterial-as/catalog/en/terms_of_trade_en.pdf

Catalogs

Digital Factory, Process Industries and Drives and Energy Management

Further information can be obtained from our branch offices listed at www.siemens.com/lowvoltage/contact

Interactive Catalog	<i>Catalog</i>	Process Instrumentation and Analytics	<i>Catalog</i>
Products for Automation and Drives	CA 01	<i>Digital: Field Instruments for Process Automation</i>	<i>FI 01</i>
Building Control		<i>Digital: Display Recorders SIREC D</i>	<i>MP 20</i>
GAMMA Building Control	ET G1	<i>Digital: SIPART Controllers and Software</i>	<i>MP 31</i>
Drive Systems		Products for Weighing Technology	WT 10
SINAMICS G130 Drive Converter Chassis Units	D 11	<i>Digital: Process Analytical Instruments</i>	AP 01
SINAMICS G150 Drive Converter Cabinet Units		<i>Digital: Process Analytics, Components for Continuous Emission Monitoring</i>	AP 11
<i>Digital: SINAMICS PERFECT HARMONY GH180 Medium-Voltage Air-Cooled Drives (Germany Edition)</i>	D 15.1	Low-Voltage Power Distribution and Electrical Installation Technology	
SINAMICS G180 Converters – Compact Units, Cabinet Systems, Cabinet Units Air-Cooled and Liquid-Cooled	D 18.1	SENTRON · SIVACON · ALPHA	LV 10
SINAMICS S120 Chassis Format Converter Units	D 21.3	Protection, Switching, Measuring and Monitoring Devices, Switchboards and Distribution Systems	
SINAMICS S120 Cabinet Modules		Electrical Components for the Railway Industry	LV 12
SINAMICS S150 Converter Cabinet Units		Power Monitoring Made Simple	LV 14
SINAMICS S120 and SIMOTICS	D 21.4	Components for Industrial Control Panels according to UL Standards	LV 16
SINAMICS DCM DC Converter, Control Module	D 23.1	<i>Digital: Air circuit breakers and molded case circuit breakers with UL certification</i>	LV 18
SINAMICS Inverters for Single-Axis Drives · Built-In Units	D 31.1	3WT Air Circuit Breakers up to 4000 A	LV 35
SINAMICS Inverters for Single-Axis Drives · Distributed Inverters	D 31.2	3VT Molded Case Circuit Breakers up to 1600 A	LV 36
<i>Digital: SINAMICS S210 Servo Drive System</i>	D 32	<i>Digital: SIVACON System Cubicles, System Lighting and System Air-Conditioning</i>	LV 50
<i>Digital: SINAMICS V90 Basic Servo Drive System</i>	D 33	<i>Digital: ALPHA Distribution Systems</i>	LV 51
<i>Digital: SINAMICS G120P and SINAMICS G120P Cabinet pump, fan, compressor converters</i>	D 35	ALPHA FIX Terminal Blocks	LV 52
LOHER VARIO High Voltage Motors	D 83.2	SIVACON S4 Power Distribution Boards	LV 56
Flameproof, Type Series 1PS4, 1PS5, 1MV4 and 1MV5 Frame Size 355 to 1000, Power Range 80 to 7100 kW		SIVACON 8PS Busbar Trunking Systems	LV 70
<i>Digital: Three-Phase Induction Motors SIMOTICS HV, SIMOTICS TN</i>	D 84.1	<i>Digital: DELTA Switches and Socket Outlets</i>	ET D1
<i>Digital: Three-Phase Induction Motors SIMOTICS HV</i>	D 84.3	Vacuum Switching Technology and Components for Medium Voltage	HG 11.01
High Voltage Three-phase Induction Motors	D 84.9	Power Supply	
SIMOTICS HV Series A-compact PLUS		SITOP Power supply	KT 10.1
<i>Digital: Modular Industrial Generators SIGENTICS M</i>	D 85.1	Safety Integrated	
Synchronous Motors with Permanent-Magnet Technology, HT-direct	D 86.2	Safety Technology for Factory Automation	SI 10
DC Motors	DA 12	SIMATIC HMI / PC-based Automation	
SIMOVERT PM Modular Converter Systems	DA 45	Human Machine Interface Systems/ PC-based Automation	ST 80/ ST PC
MICROMASTER 420/430/440 Inverters	DA 51.2	SIMATIC Ident	
MICROMASTER 411/COMBIMASTER 411	DA 51.3	Industrial Identification Systems	ID 10
<u>Low-Voltage Three-Phase-Motors</u>		SIMATIC Industrial Automation Systems	
SIMOTOCS S-1FG1 Servo geared motors	D 41	Products for Totally Integrated Automation	ST 70
SIMOTICS Low-Voltage Motors	D 81.1	SIMATIC PCS 7 Process Control System	ST PCS 7
SIMOTICS FD Low-Voltage Motors	D 81.8	System components	
LOHER Low-Voltage Motors	D 83.1	SIMATIC PCS 7 Process Control System Technology components	ST PCS 7 T
<i>Digital: MOTOX Geared Motors</i>	D 87.1	Add-ons for the SIMATIC PCS 7 Process Control System	ST PCS 7 AO
SIMOGEAR Geared Motors	MD 50.1	SIMATIC S7-400 advanced controller	ST 400
SIMOGEAR Electric-monorail geared motors	MD 50.8		
Light-load and heavy-load applications		SIMATIC NET	
SIMOGEAR Gearboxes with adapter	MD 50.11	Industrial Communication	IK PI
<u>Mechanical Driving Machines</u>		SIRIUS Industrial Controls	
FLENDER Standard Couplings	MD 10.1	<i>Digital: SIRIUS Industrial Controls</i>	IC 10
FLENDER High Performance Couplings	MD 10.2		
FLENDER Backlash-free Couplings	MD 10.3		
FLENDER SIP Standard industrial planetary gear units	MD 31.1		
Motion Control			
SINUMERIK 840 Equipment for Machine Tools	NC 62		
SINUMERIK 808 Equipment for Machine Tools	NC 81.1		
SINUMERIK 828 Equipment for Machine Tools	NC 82		
SIMOTION Equipment for Production Machines	PM 21		
<i>Digital: Drive and Control Components for Cranes</i>	CR 1		

Digital: These catalogs are only available as a PDF.

Siemens Industry Online Support

Digital versions of the catalogs are available on the Internet at:
www.siemens.com/lowvoltage/catalogs

Siemens AG
Energy Management
Low Voltage & Products
Postfach 10 09 53
93009 REGENSBURG
GERMANY

Subject to change without prior notice
PDF (E86060-K1831-A101-A4-7600)
KG 1018 88 EN
Produced in Germany
© Siemens AG 2018

The information provided in this catalog contains merely general descriptions or characteristics of performance which in case of actual use do not always apply as described or which may change as a result of further development of the products. An obligation to provide the respective characteristics shall only exist if expressly agreed in the terms of contract. Availability and technical specifications are subject to change without notice.
All product designations may be trademarks or product names of Siemens AG or supplier companies whose use by third parties for their own purposes could violate the rights of the owners.